



Extracting Forceps, English Pattern
Zahnzangen, englische form
Forceps de extracción, forma inglesa
Daviers, forma anglaise
Pinze per estrazioni, forma inglese

Tel# 0092-52-4260785
Fax# 0092-52-4266804
Email. Info@benison.com.pk



01-0101
Fig.1



01-0102
Fig.2



01-0103
Fig.3



01-0104
Fig.4



01-0107
Fig.7



01-0108
Fig.8



01-0113
Fig.13

- 01-0101 For Upper Centrals And Canines
- 01-0102 For Upper Laterals And Bicusprds
- 01-0103 For Upper Incisors And Canines
Crowded Internally Or Externally
- 01-0104 For Lower Incisors And Canines
- 01-0107 For Upper Bicuspids Either Side
- 01-0108 For Lower Bicuspids Either Side
- 01-0113 For Lower Bicuspids Either Side



01-0117
Fig. 17

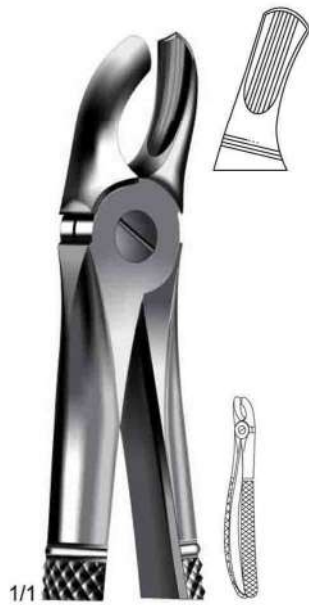

01-0118
Fig. 18



01-0218
Fig. 18 A



01-0219
Fig. 19



01-0220
Fig. 20



01-0221
Fig. 21



01-0222
Fig. 22

- 01-0117 | For Right Upper Molars
- 01-0118 | For Left Upper Molars
- 01-0218 | For Upper Molars, Either Side
- 01-0219 | For Upper Wisdoms, Either Side
- 01-0220 | For Lower Wisdoms, Either Side
- 01-0221 | For Lower Molars, Either Side
- 01-0222 | For Lower Molars, Either Side (Hawk's Bill)

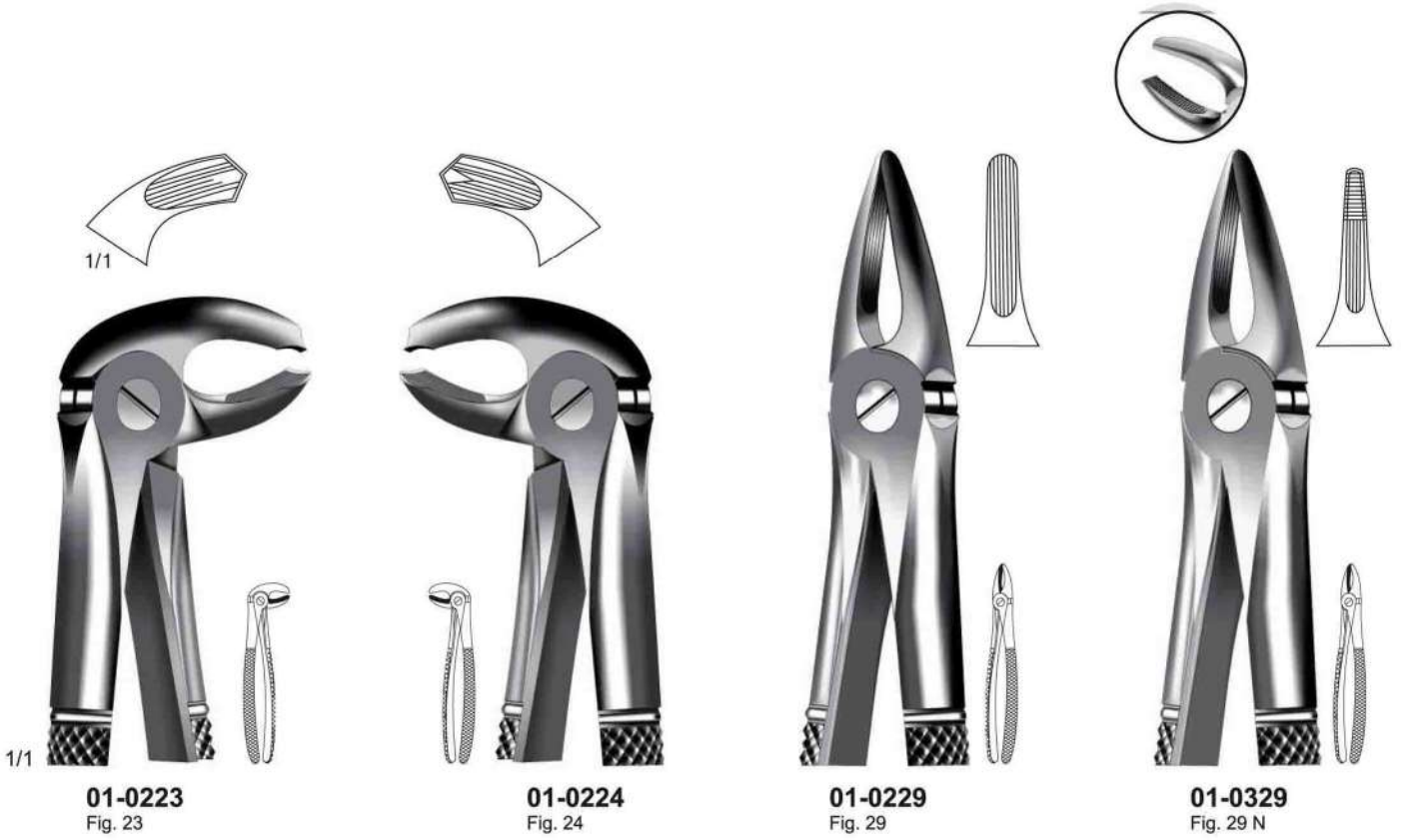

- 01-0233 For Right Lower Molars
- 01-0224 For Left Lower Molars
- 01-0229 For Upper Roots And Incisors, Either Side
- 01-0329 For Roots Of Upper Incisors
- 01-0330 For Lower Roots And Incisors
- 01-0331 For Lower Roots, Either Side
- 01-0333 For Lower Roots, Either Side
- 01-0433 For Lower Roots, Either Side



01-0533
Fig. 33 C



01-0633
Fig. 33 M



01-0641
Fig. 41



01-0644
Fig. 44



01-0645
Fig. 45



01-0651
Fig. 51

- 01-0533 For Lower Roots, Either Side, Slender Pattern
- 01-0633 For Lower Roots, Either Side, Slender Pattern
- 01-0641 For Upper Roots, Either Side
- 01-0644 For Upper Roots, Either Side
- 01-0645 For Lower Roots, Either Side
- 01-0651 For Upper Roots



01-0751
Fig. 51 A

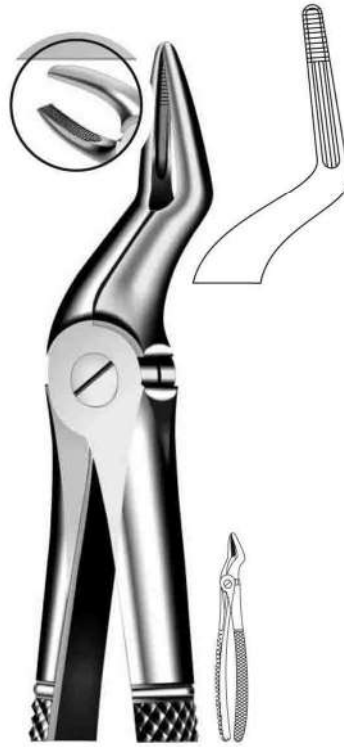

01-0851
Fig. 51 C



Mod. Pro
01-0951
Fig. 51 M

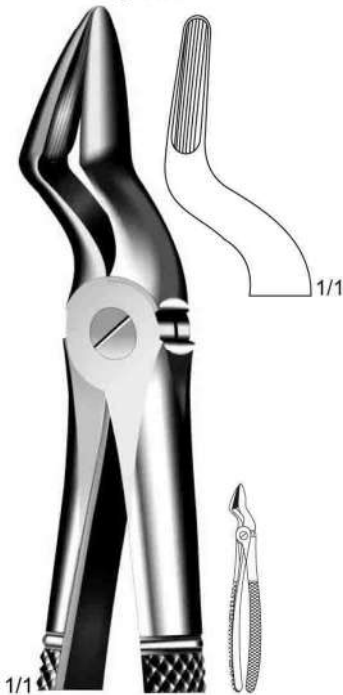

01-0952
Fig. 52

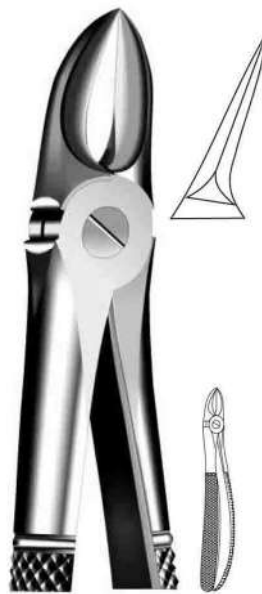

01-0955
Fig. 55

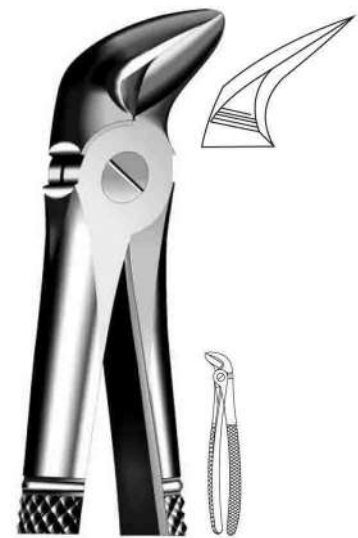

01-0956
Fig. 56

- 01-0751 For Upper Roots, Very Narrow Beak
- 01-0851 For Upper Roots
- 01-0951 For Upper Roots With Very Long Beak For Deep Upper Roots
- 01-0952 For Upper Roots And Canines, With Wider Beak
- 01-0955 For Separating Upper Molar
- 01-0956 For Separating Lower Molar



01-0967
Fig. 67



01-1067
Fig. 67 A



01-1073
Fig. 73



01-1074
Fig. 74



01-1174
Fig. 74 M



01-1274
Fig. 74 N



01-1275
Fig. 75

- 01-0967 For Upper Wisdoms, Either Side
- 01-1067 For Upper Wisdoms, Either Side
- 01-1073 For Lower Molars, Either Side (Hawk's Bill)
- 01-1074 For Lower Incisors And Roots
- 01-1174 For Lower Incisors And Roots
- 01-1274 For Lower Incisors And Roots
- 01-1275 For Lower Bicuspid And Canines (either Side)

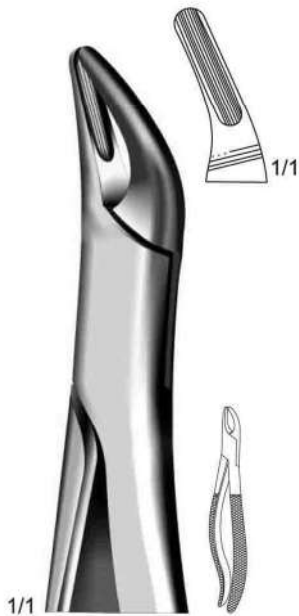

Lowrence Read
01-1276
Fig. 76



Lowrence Read
01-1376
Fig. 76 N



01-1379
Fig. 79



01-1479
Fig. 79 A



01-1486
Fig. 86 A



01-1586
Fig. 86 B



01-1686
Fig. 86 C

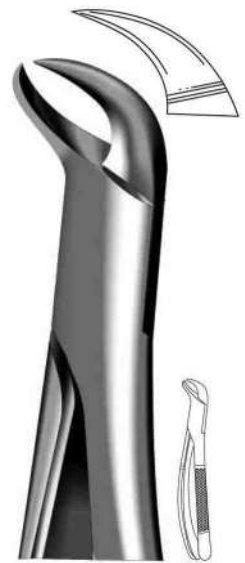

01-1687
Fig. 87

- 01-1276 For Upper Roots, Either Side
- 01-1376 For Upper Roots, Either Side (with Narrow Beak)
- 01-1379 For Lower Wisdoms (either Side)
- 01-1479 For Lower Wisdoms (either Side)
- 01-1486 For Lower Molar With Decayed Or Broken Down Crowns, Either Side
- 01-1586 For Lower Molar With Decayed Or Broken Down Crowns, Either Side
- 01-1686 For Lower Molar With Decayed Or Broken Down Crowns, Either Side
- 01-1687 For Lower Molar With Decayed Or Broken Down Crowns, Either Side

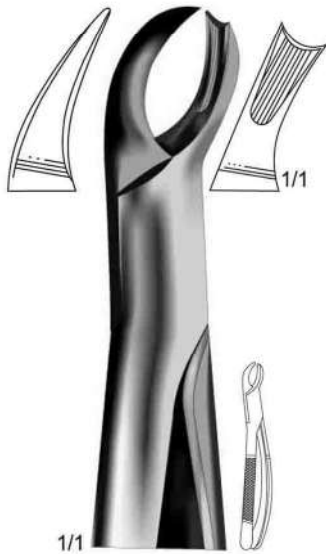

1/1
01-1689
Fig. 89



01-1690
Fig. 90



01-1694
Fig. 94



01-1695
Fig. 95



01-1699
Fig. 99

- 01-1689 For Right Upper Molars
- 01-1690 For Left Upper Molars
- 01-1694 For Right Upper Molars
- 01-1695 For Left Upper Molars
- 01-1699 For Broken Down Lower Molar

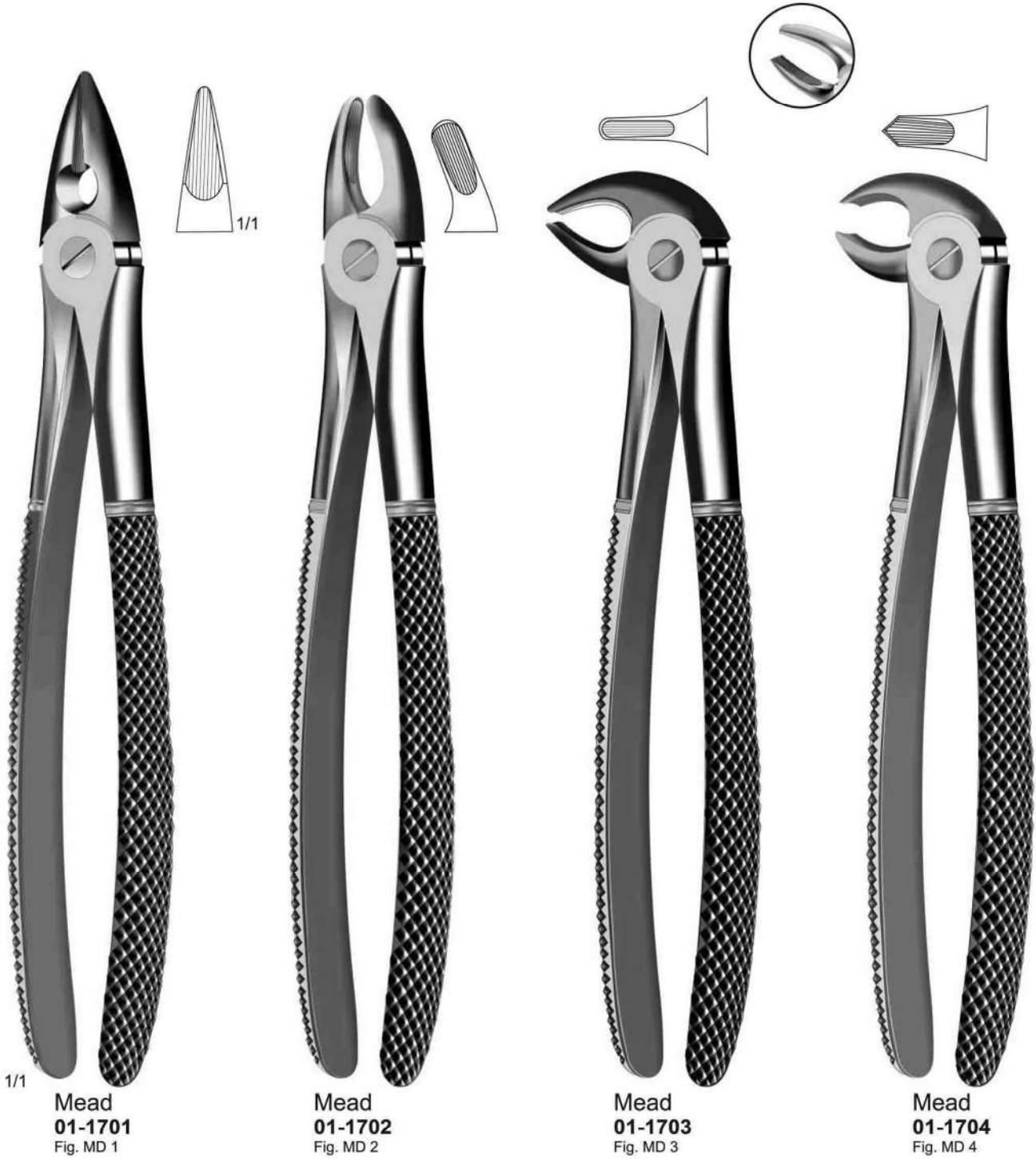

- 01-1701 Universal Forceps For Upper Wisdoms, Bicuspids And Upper Roots
- 01-1702 For Upper Molars
- 01-1703 For Lower Incisors, Bicuspids And Roots
- 01-1704 For Lower Molars



Alpha handle

All preceding extracting forceps in English pattern are also available with **Alfa handle**.

Just replace first two article numbers, "01-" with "02-". Please refer to column "C" below.

Article numbers

A	B	C	A	B	C	A	B	C
Normal handle	Non-Slip Grip	Alfa handle	Normal handle	Non-Slip Grip	Alfa handle	Normal handle	Non-Slip Grip	Alfa handle
01-0101	01-0101 NS	02-0101	01-0333	01-0333 NS	02-0333	01-1376	01-1376 NS	02-1376
01-0102	01-0102 NS	02-0102	01-0433	01-0433 NS	02-0433	01-1379	01-1379 NS	02-1379
01-0104	01-0104 NS	02-0104	01-0533	01-0533 NS	02-0533	01-1479	01-1479 NS	02-1479
01-0107	01-0107 NS	02-0107	01-0633	01-0633 NS	02-0633	01-1486	01-1486 NS	02-1486
01-0108	01-0108 NS	02-0108	01-0641	01-0641 NS	02-0641	01-1586	01-1586 NS	02-1586
01-0113	01-0113 NS	02-0113	01-0644	01-0644 NS	02-0644	01-1686	01-1686 NS	02-1686
01-0117	01-0117 NS	02-0117	01-0645	01-0645 NS	02-0645	01-1687	01-1687 NS	02-1687
01-0118	01-0118 NS	02-0118	01-0651	01-0651 NS	02-0651	01-1689	01-1689 NS	02-1689
01-0218	01-0218 NS	02-0218	01-0751	01-0751 NS	02-0751	01-1690	01-1690 NS	02-1690
01-0219	01-0219 NS	02-0219	01-0851	01-0851 NS	02-0851	01-1694	01-1694 NS	02-1694
01-0220	01-0220 NS	02-0220	01-0951	01-0951 NS	02-0951	01-1695	01-1695 NS	02-1695
01-0221	01-0221 NS	02-0221	01-0952	01-0952 NS	02-0952	01-1699	01-1699 NS	02-1699
01-0222	01-0222 NS	02-0222	01-0955	01-0955 NS	02-0955	01-1701	01-1701 NS	02-1701
01-0223	01-0223 NS	02-0223	01-0956	01-0956 NS	02-0956	01-1702	01-1702 NS	02-1702
01-0224	01-0224 NS	02-0224	01-1074	01-1074 NS	02-1074	01-1703	01-1703 NS	02-1703
01-0229	01-0229 NS	02-0229	01-1174	01-1174 NS	02-1174	01-1704	01-1704 NS	02-1704
01-0329	01-0329 NS	02-0329	01-1274	01-1274 NS	02-1274			
01-0330	01-0330 NS	02-0330	01-1275	01-1275 NS	02-1275			
01-0331	01-0331 NS	02-0331	01-1276	01-1276 NS	02-1276			

Non-Slip Grip Jaws



All preceding extracting forceps in English pattern are also available in **Non-Slip Grip Jaws**.

Please add "NS" with existing article numbers. e.g **01-0101NS**. Please refer to column B.





03-1839
 Fig. 39
 For upper molars, either side



03-1939
 Fig. 39 A
 For upper molars, either side



03-2039
 Fig. 39 L
 For left upper molar



03-1810

Instrument set of 10

03-1837	03-1813
03-1839	03-1830
03-2139	03-1833
03-2039	03-1822
03-2151	03-1838



03-2139
 Fig. 39 R
 For right upper molar



03-2140
 Fig. 40
 For lower molars, either side



03-2151
 Fig. 51 S
 For upper roots, either side

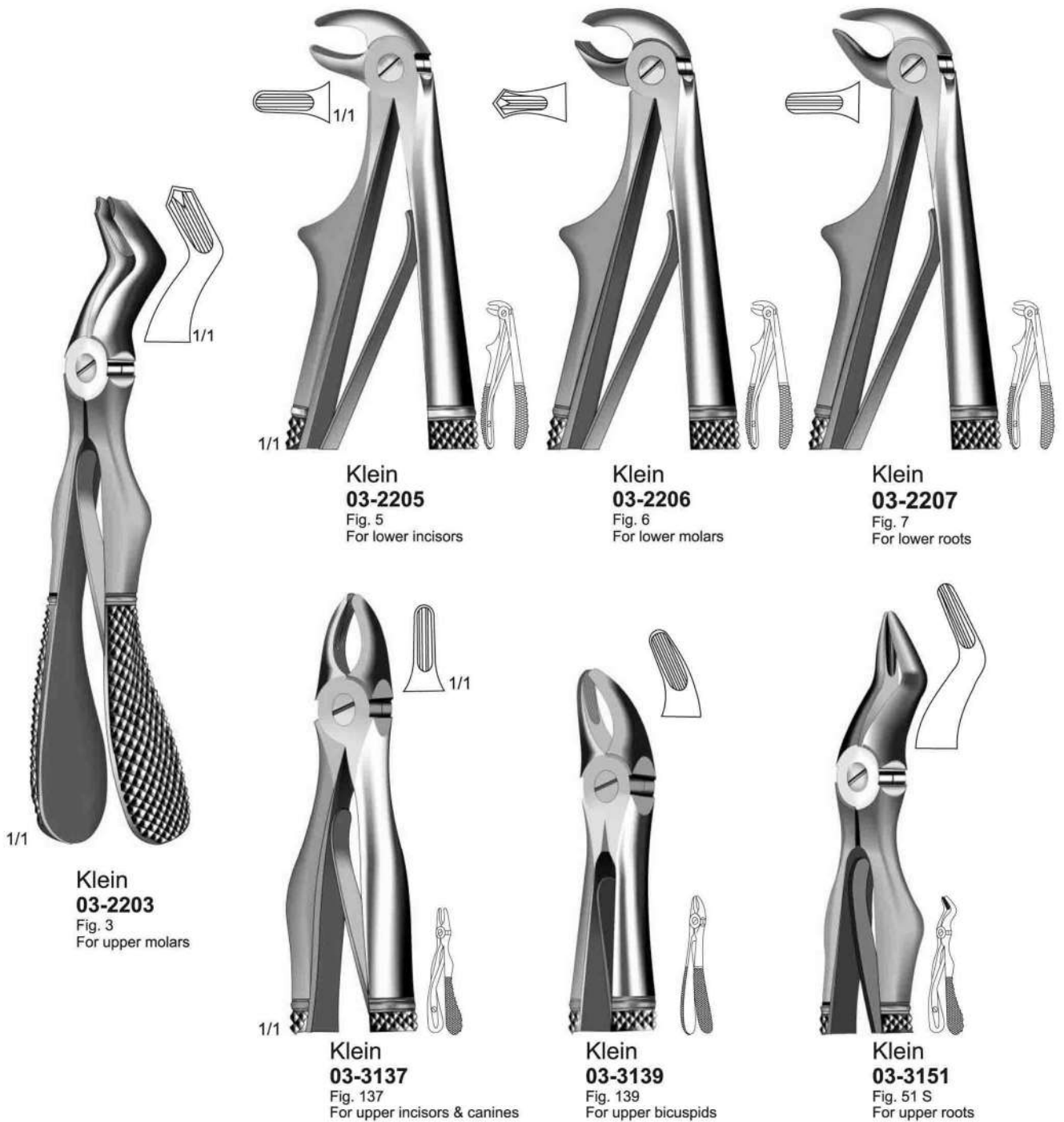

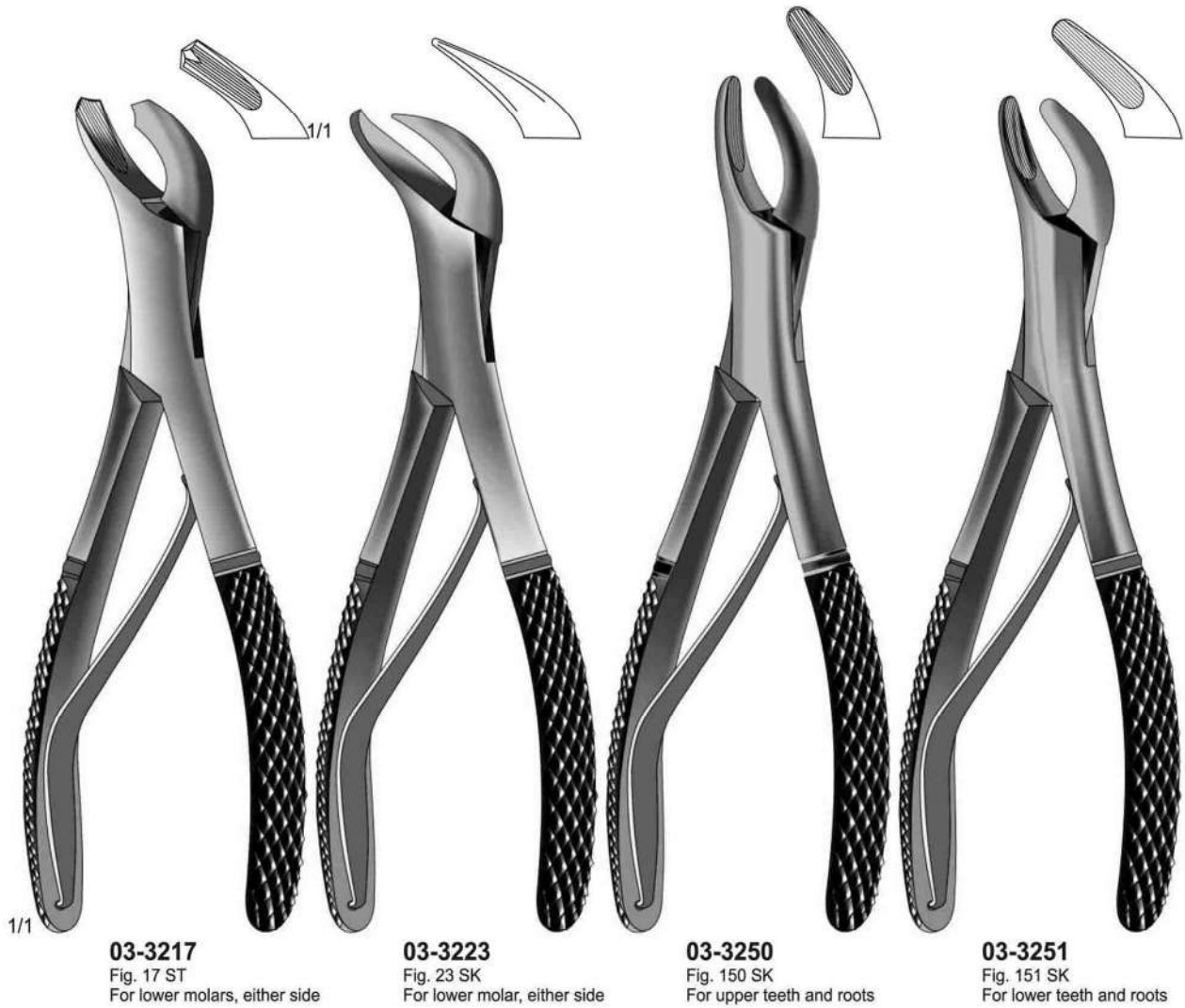



1/1
Standard
04-0101
 Fig. 1
 For upper centrals,
 laterals and cuspids

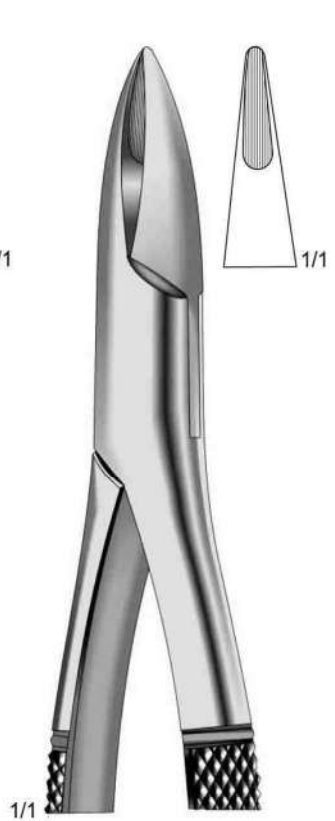

1/1
Henahan
04-0201
 Fig. 1 A
 For upper incisors



1/1
Physick
04-0205
 Fig. 5
 For lower third molars
 either side



1/1
04-0206
 Fig. 6
 Splitting or separating
 forceps



Woodward
04-0203
Fig. 3 FH
For lower molars



04-0310 - 04-0410
Fig. 10 H / Fig. 10 S
For upper molars, either side

04-0310
Fig. 10 H

04-0410
Fig. 10 S



Harris
04-0415
Fig. 15

04-0416
Fig. 16
For lower molars

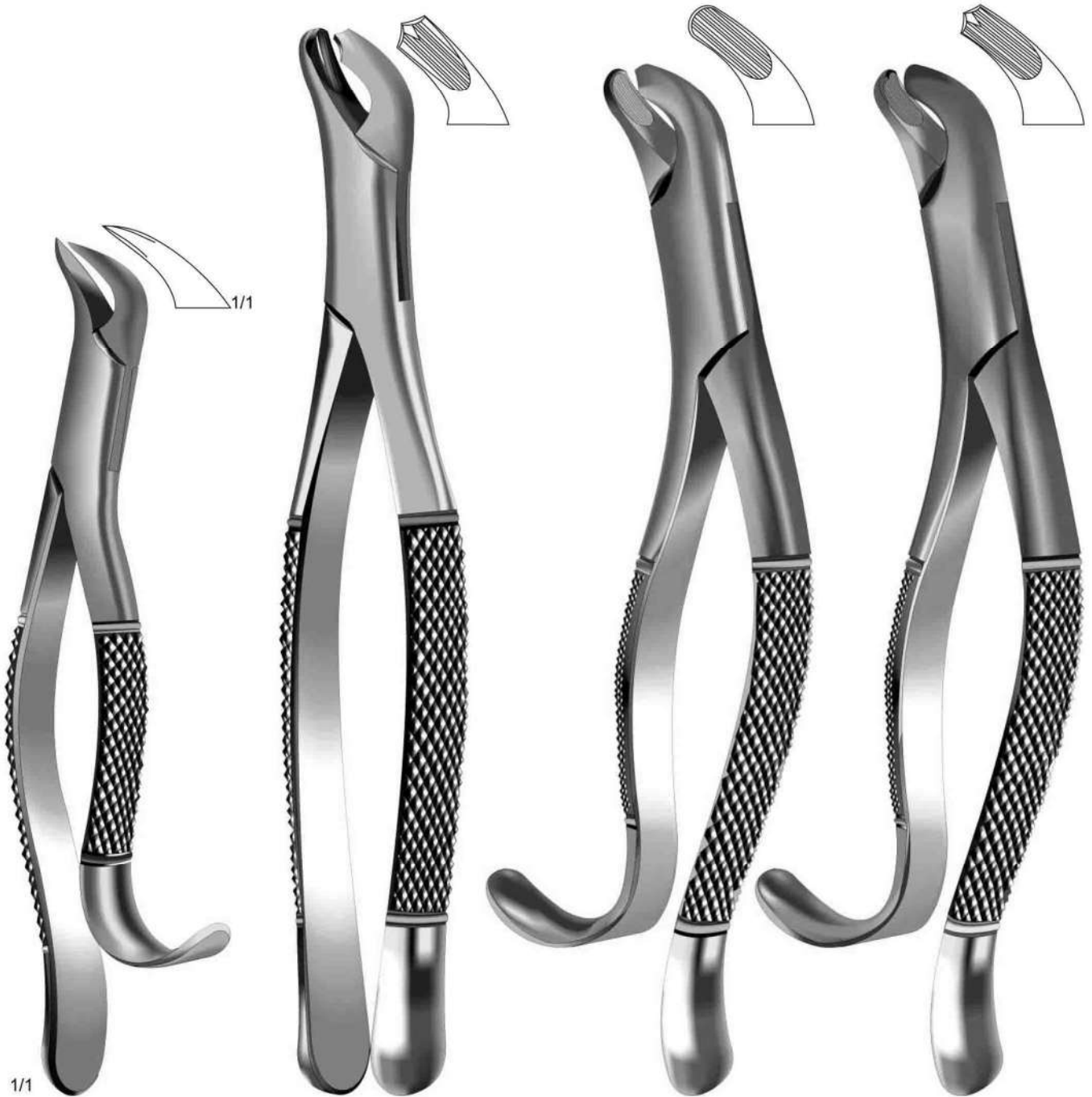

04-0516
Fig .16 S

04-0517
Fig .17

Harris
04-0618
Fig .18 L

Harris
04-0718
Fig .18 R

- 04-0516 | For Lower Molars, Either Side, For Children
- 04-0517 | For Lower Molars, Either Side
- 04-0618 | For Upper Molars, Left Side
- 04-0718 | For Upper Molars, Right Side



04-0723
Fig. 23
For lower molars, either side

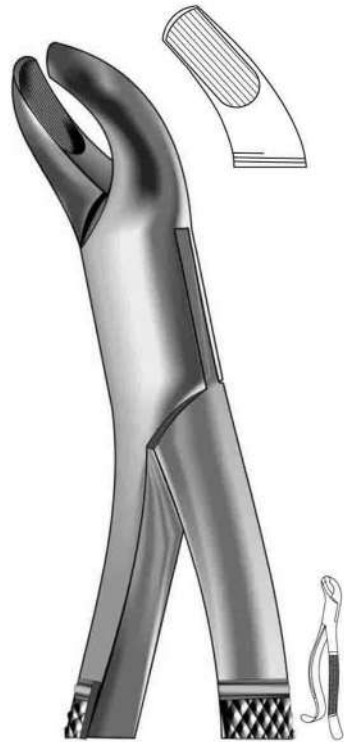

04-0724
Fig. 24
For upper molars, either side

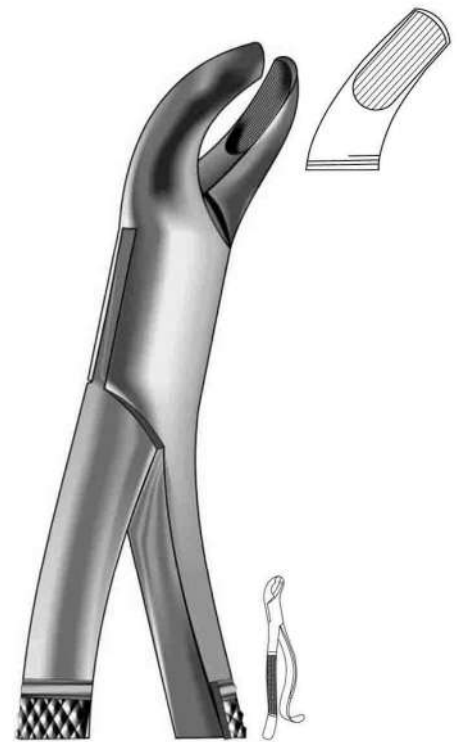

04-0727
Fig. 27

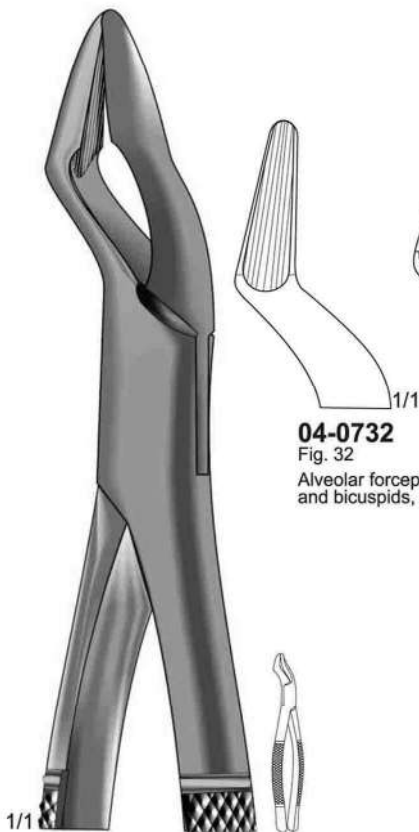

04-0732
Fig. 32
Alveolar forceps for upper molars
and bicuspid, strong beak



04-0853
Fig. 53 L
For upper
molars left side



04-0953
Fig. 53 R
For upper
molars right side

Parmly
04-0732 - 04-0832

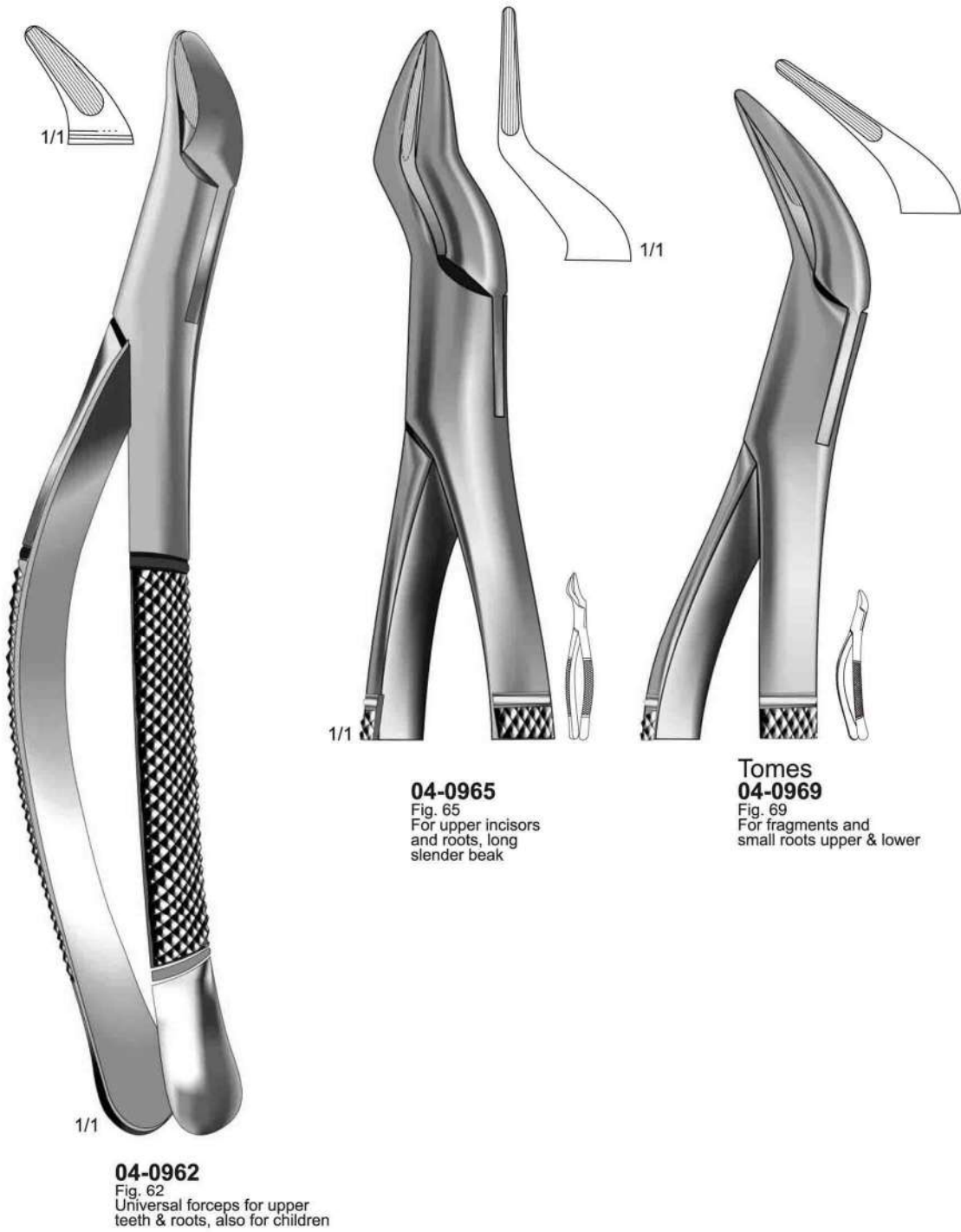



Hull
04-1101
Fig. 101
Universal forceps for
bicuspid and milk teeth

04-1103
Fig. 103
For lower bicuspid
incisors, roots, either side



Nevius
04-1188
Fig. 88 L
For left upper molar

Nevius
04-1288
Fig. 88 R
For right upper molar



Kells
04-1299
Fig .99 A
For upper bicuspids,
cuspid and incisors



Kells
04-1399
Fig .99 C
For upper bicuspids,
cuspid and incisors



Nevius
04-2110
Fig .110
For upper cuspids and bicuspid



Nevius
04-3110
Fig .110
For upper cuspids and bicuspid



Cryer
04-4150
Fig. 150



Cryer
04-5150
Fig. 150 A



Cryer
04-6150
Fig. 150 S



Cryer
04-6151
Fig. 151



Cryer
04-7151
Fig. 151 A



Cryer
04-8151
Fig. 151 S

- 04-4150 For Upper Bicuspid, Incisors And Roots
- 04-5150 For Upper Bicuspid, Incisors And Roots (but Modified)
- 04-6150 For Upper Bicuspid, Incisors And Roots
- 04-6151 For Lower Bicuspid, Incisors And Roots
- 04-7151 For Lower Bicuspid, Incisors And Roots
- 04-8151 For Lower Bicuspid, Incisors And Roots

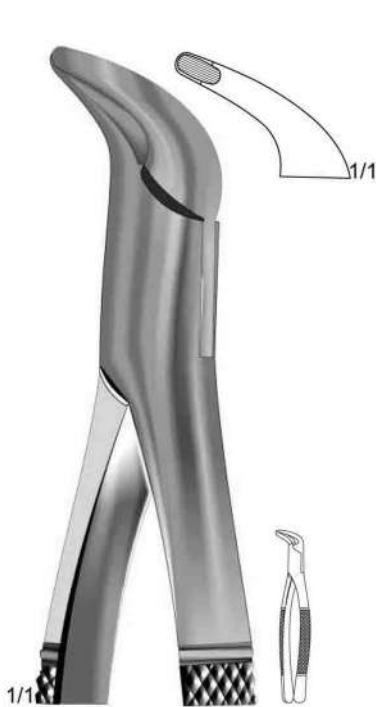

04-8203
Fig. 203

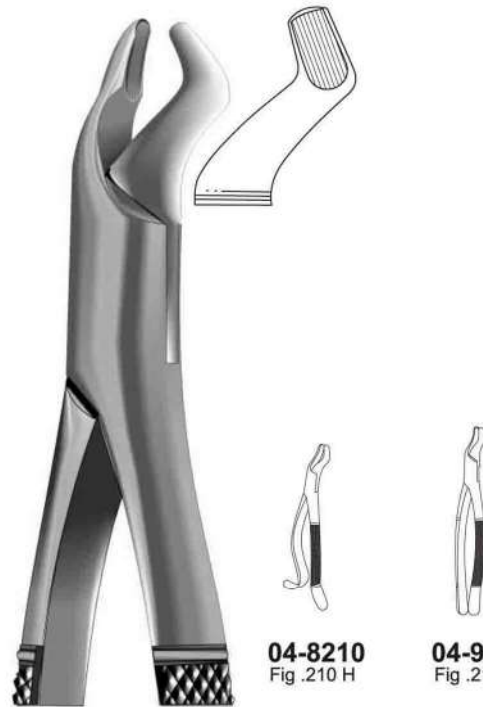

04-8210
Fig. 210 H

04-9210
Fig. 210 S

04-8210 - 04-9210



04-9217
Fig. 217

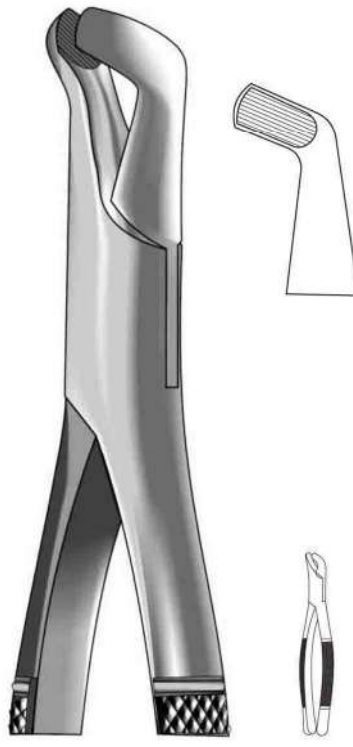

04-9222
Fig. 222

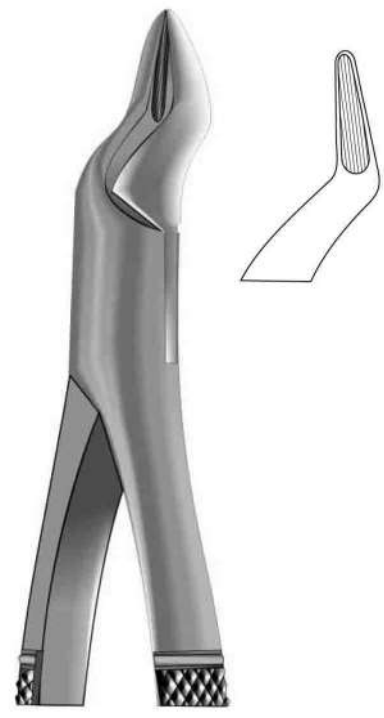

04-9286
Fig. 286

- 04-8203 | For lower bicuspid, incisors and roots, either side
- 04-8210 | For upper wisdoms, either side
- 04-9210 | For upper wisdoms, either side
- 04-9217 | For lower molars, either side
- 04-9222 | For lower wisdoms, either side
- 04-9286 | For upper roots, bicuspid and incisors, either side

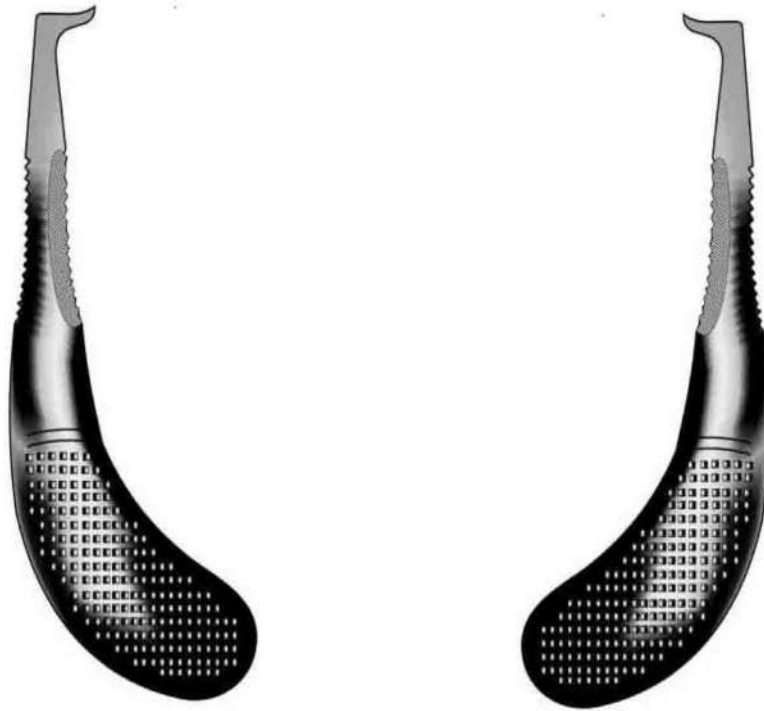

Root Elevators
Wurzelheber
Elevadores para raices
Elevateurs a racines
Leve per radici

Tel# 0092-52-4260785
Fax# 0092-52-4266804
Email. Info@benison.com.pk

www.benison.com.pk

Choice of Handles for Root Elevators.

If you wish to order a different type (A, B, C, D, E, F and G) of handle for a particular product, please mention **that** type with the code number of that product.

Example : 05-0701E

If you wish to order a particular type (A, B, C, D, E, F and G) of handle with all instruments, please mention **that** type in your purchase order.

Example : Please use handle C for all Scalers.





Bein
05-0102 - 05-0304
13.5 cm/ 5 1/4"



Hysin
05-0403 - 05-0603
14 cm/ 5 1/2"



Friedmann
05-0701 - 05-0703
14 cm/ 5 1/2"

Coupland
05-0801 - 05-0803
14 cm/ 5 1/2"

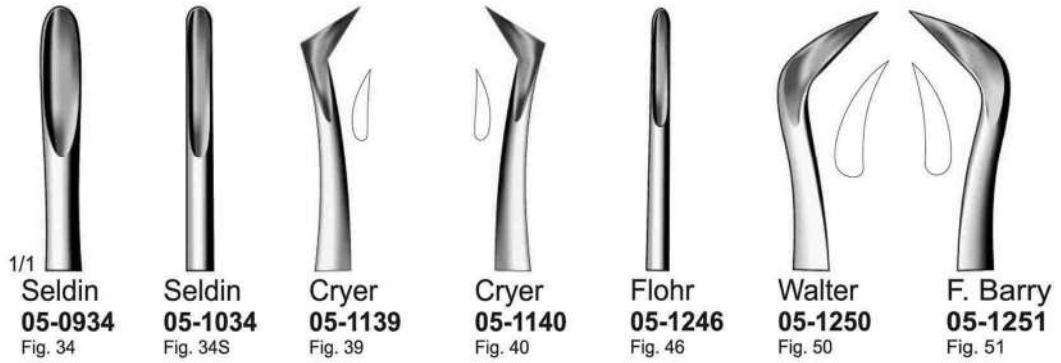

05-0934 - 05-2304
13.5 cm / 5 1/4"



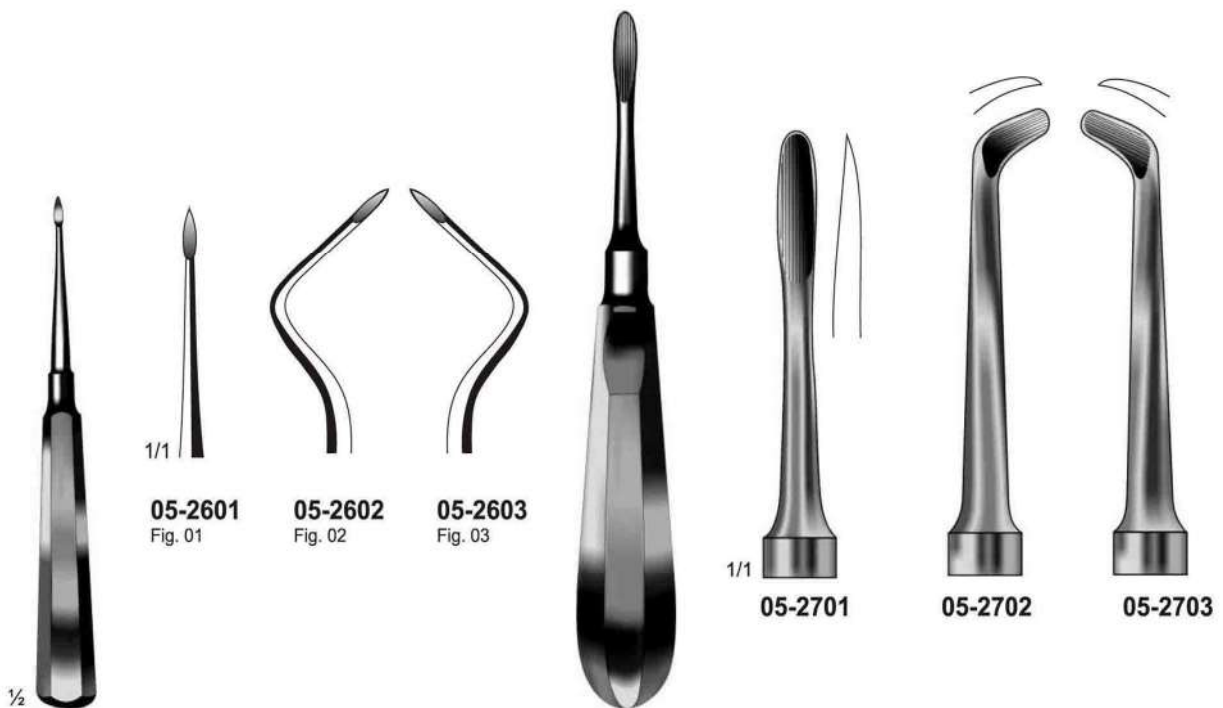
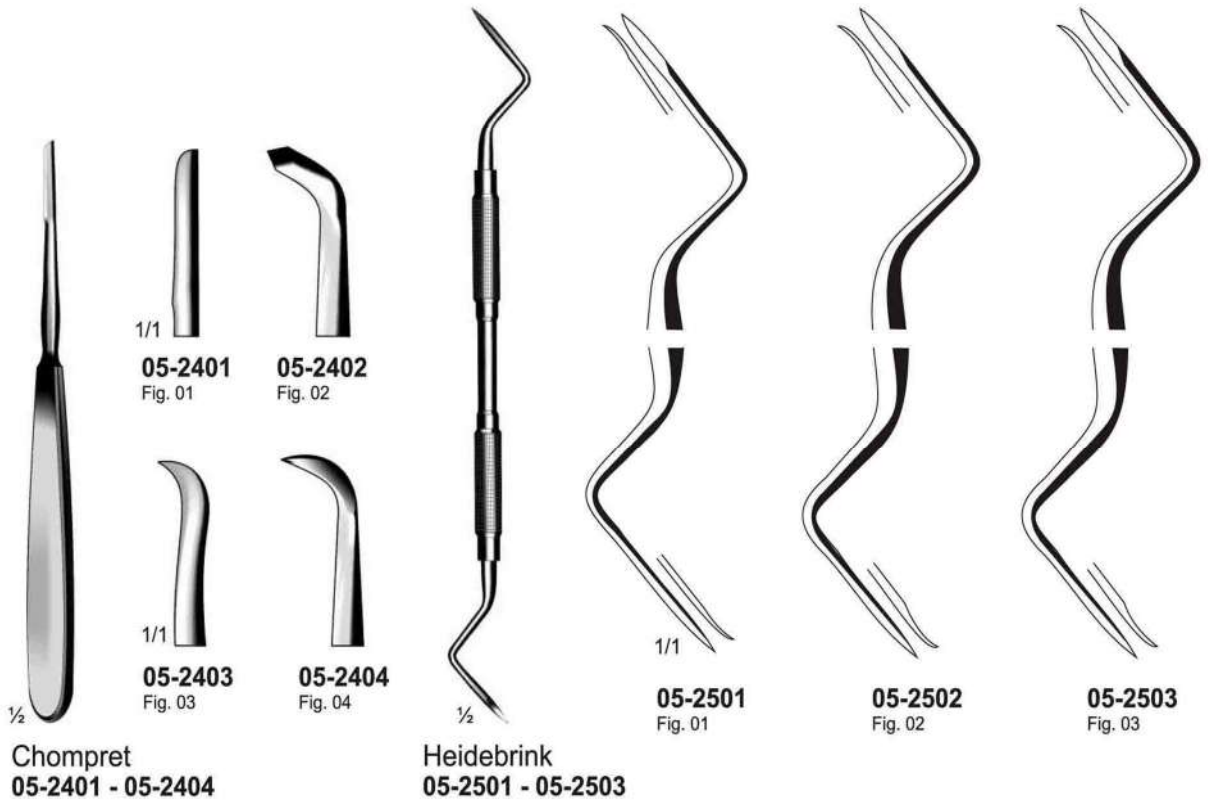

Heidebrink
05-2601 - 05-2603

Coleman
05-2701 - 05-2703
15 cm/6"



Winter
05-2801 - 05-3314



Walter F. Barry
05-4320 - 05-4371

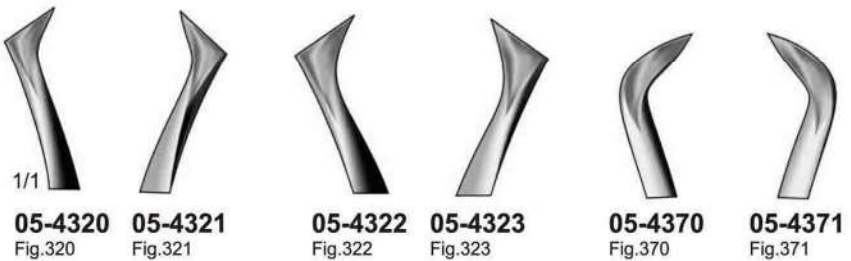



Krallengnber
05-4401



Krallengnber
05-4402



Lecluse
05-4501



Pott
05-4601 - 05-4602

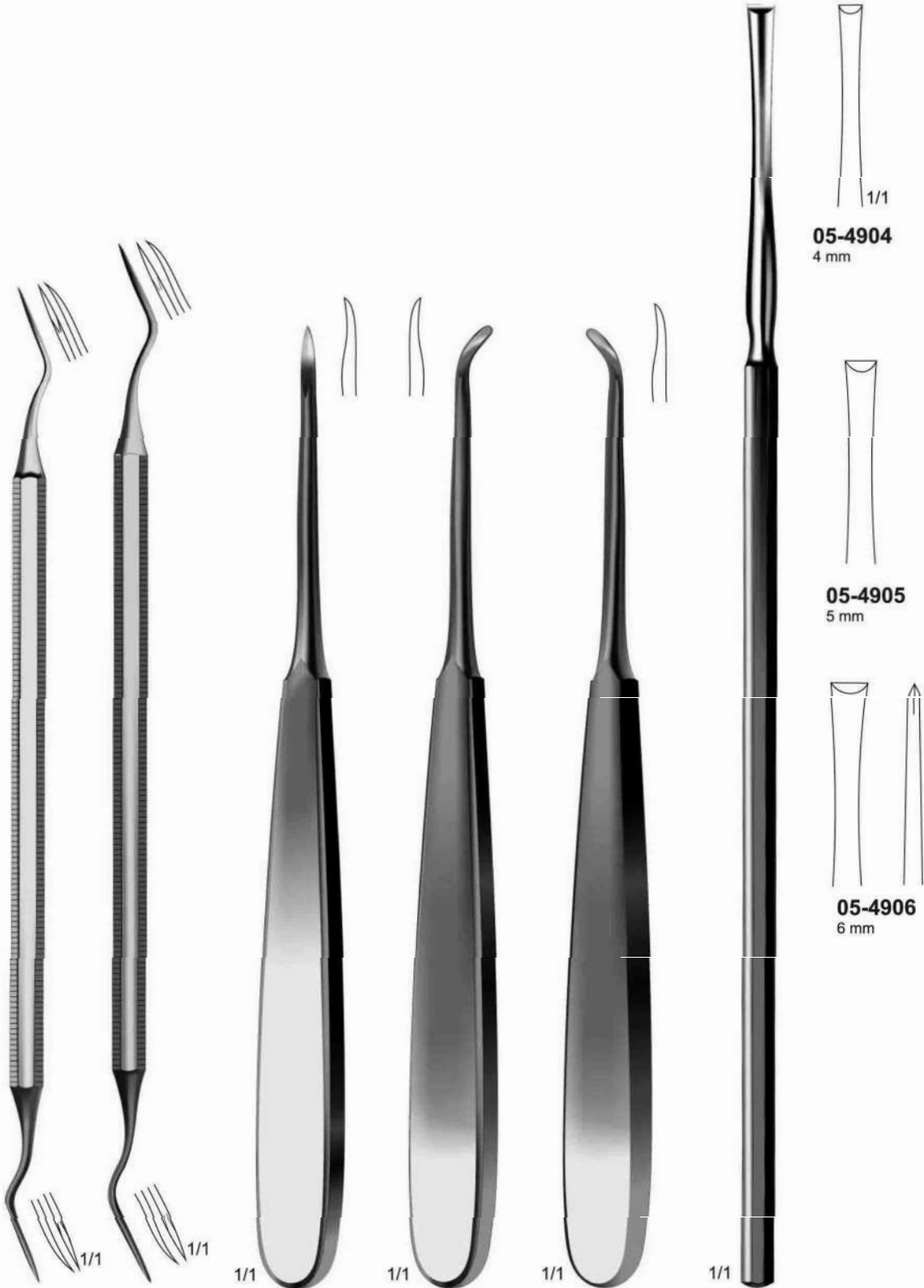

West
05-4723
Fig 2/3

West
05-4756
Fig. 5/6

Warwick-James
05-4801
16 cm/ 6 1/4"

Warwick-James
05-4802
16 cm/ 6 1/4"

Warwick-James
05-4803
16 cm/ 6 1/4"

Walter F. Barry
05-4904 - 05-4906



Amalgam Instruments
Amalgaminstruments
Instrumentos para amalgama
instruments a amalgame
strumenti per amalga

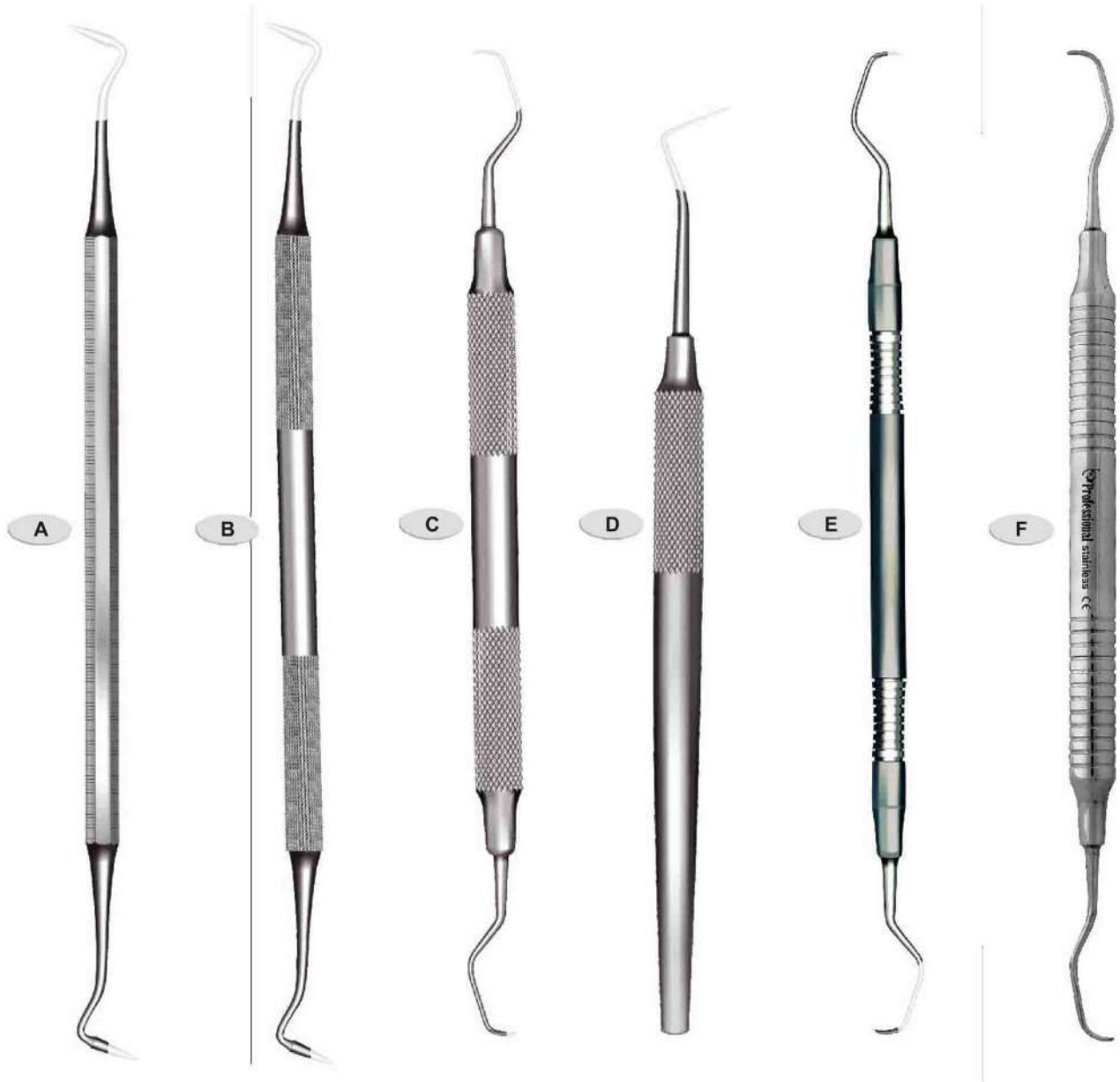

If you wish to order a different type (A, B, C, D, E and F) of handle for a particular products, please mention that type with the code number of that product.

Example : 06-1001C

If you wish to order a particular type (A, B, C, D, E and F) of handle with all instruments, please mention that type in your purchase order.

Example : Please use handle C for all Scalers.

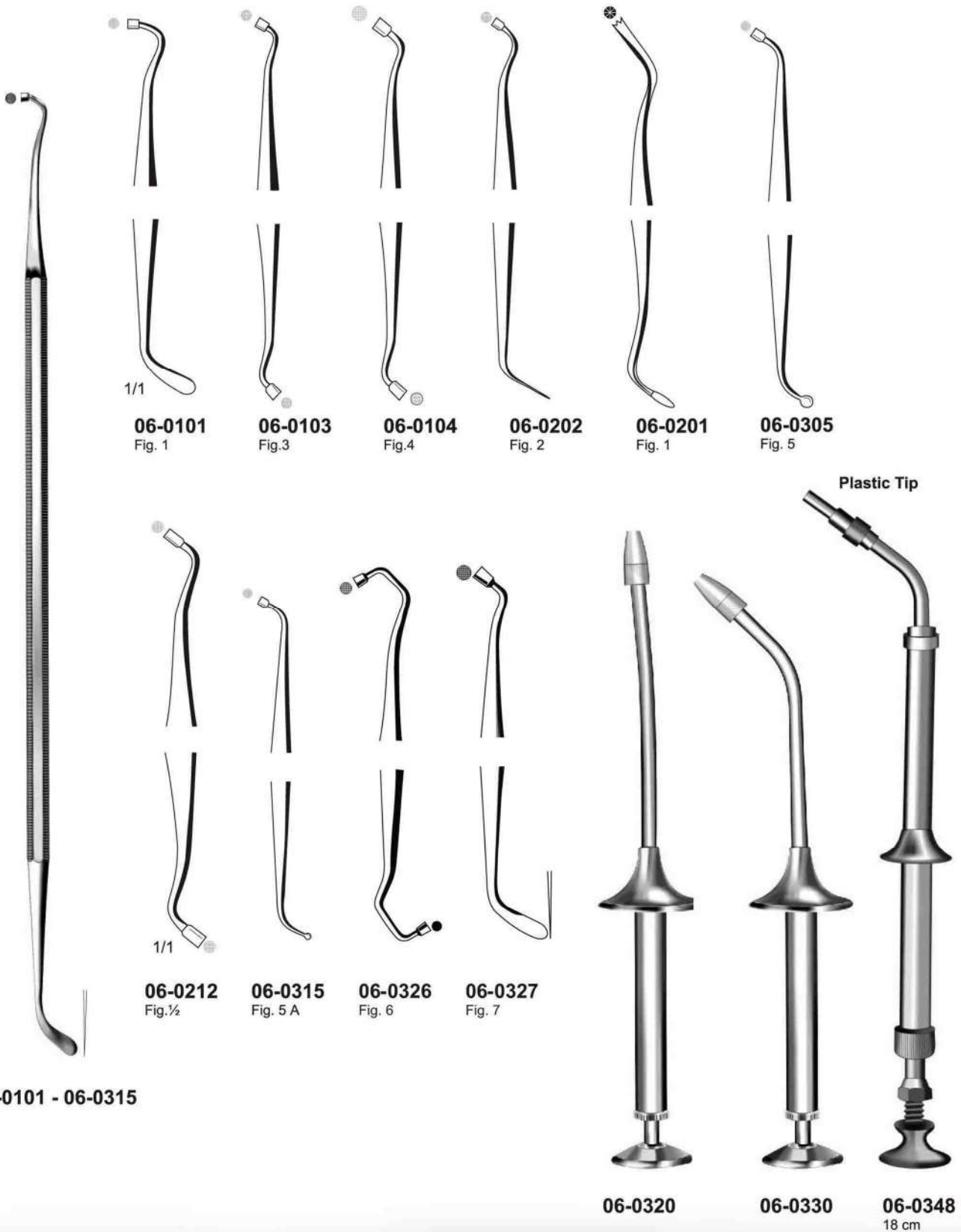

06-0101 - 06-0315

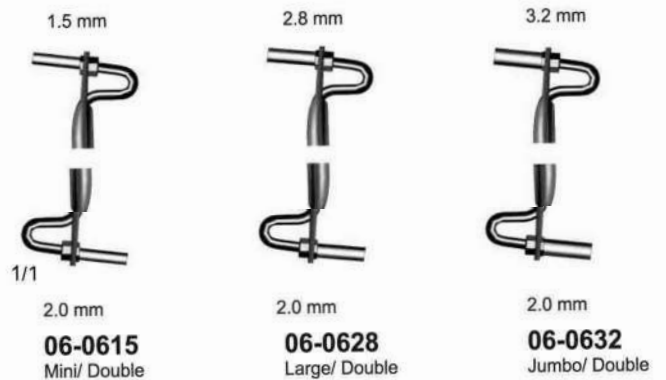
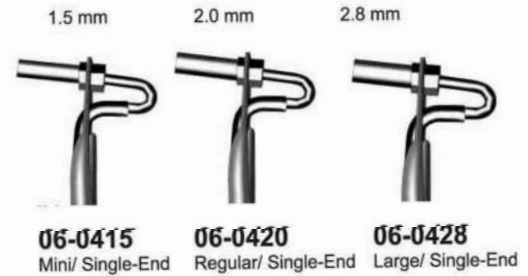

06-0730
Ø 30 mm



Amalgam well
06-0935
3,5 cm Ø
3,5 cm h.



06-0830
Ø 30 mm

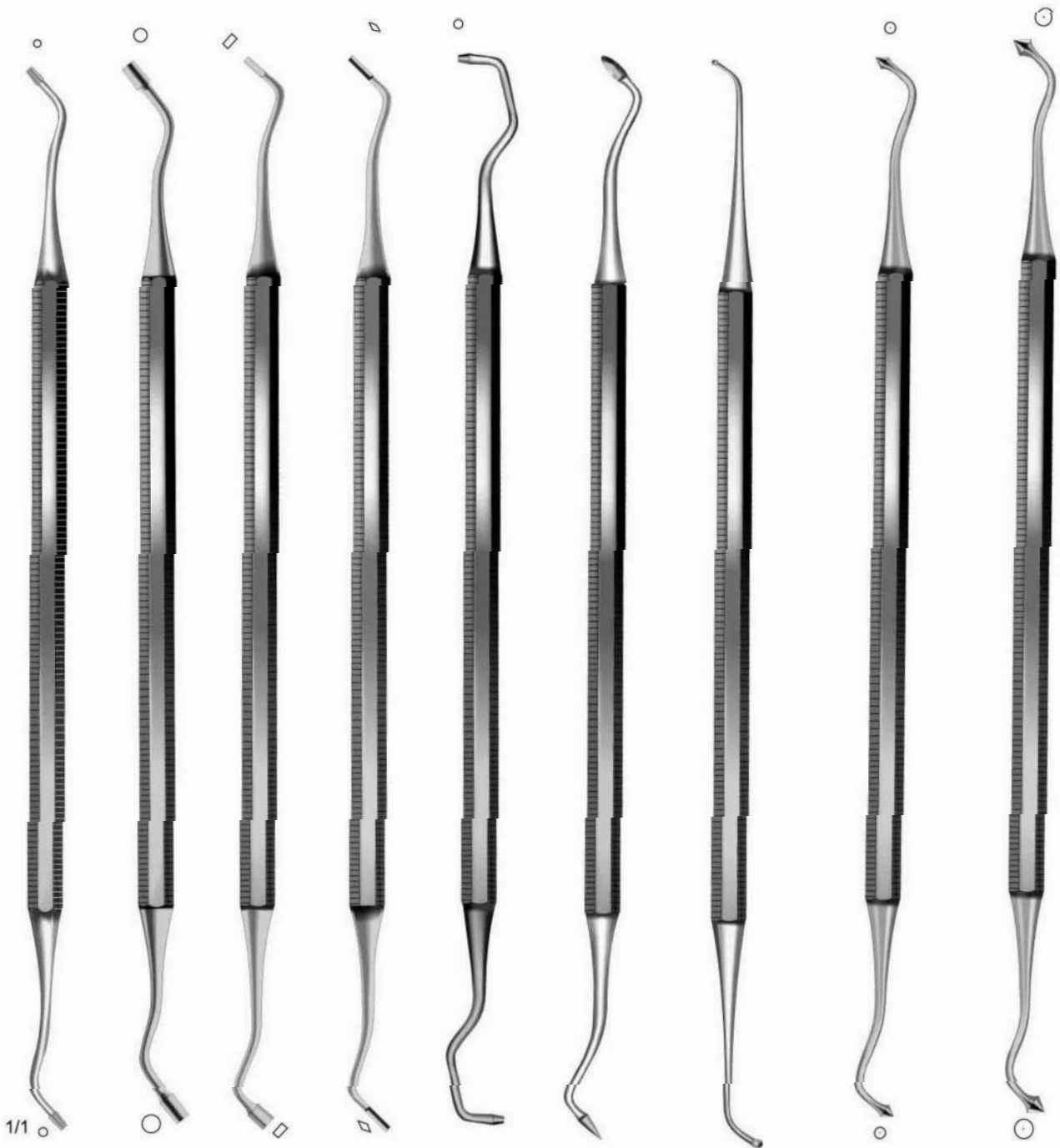

1/1 ○
○
◇
◇
○
○
○
○
○
○

— Hollenback — — Mod. USA —

06-1001 06-1002 06-1003 06-1004 06-1005 06-1006 06-1007 06-1101 06-1102



06-1201 - 06-1544
16cm/6 1/4"

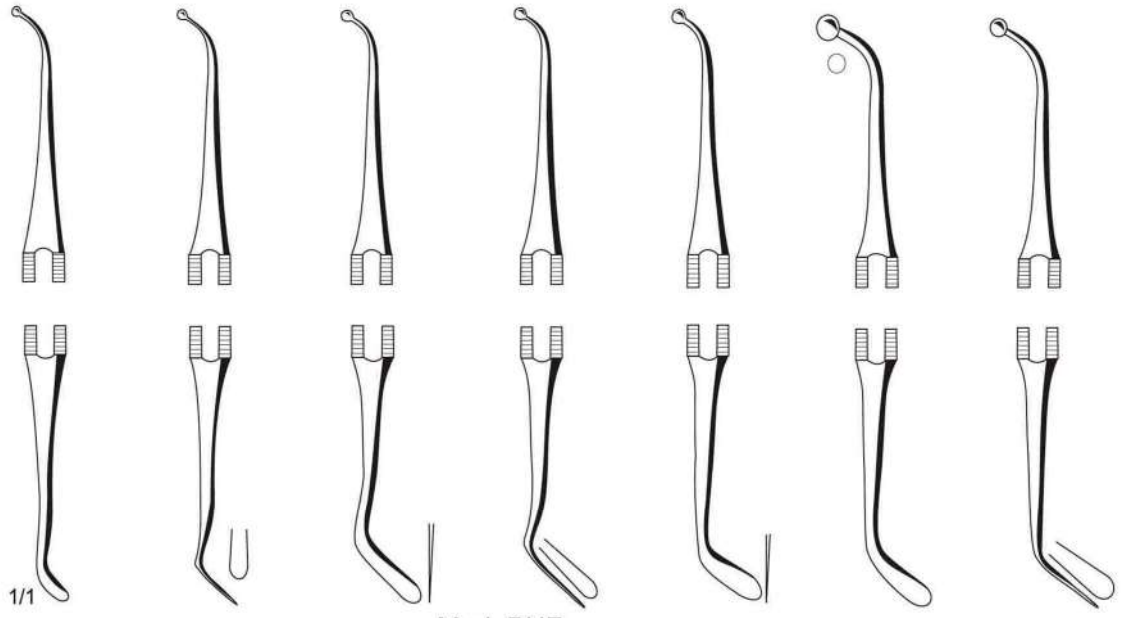

1/1
 Mod. PHF
06-1201 Fig.1 **06-1202** Fig.2 **06-1303** Fig.3 **06-1403** Fig.3 A **06-1404** Fig.4 **06-1504** Fig.4 A **06-1544** Fig.4 R

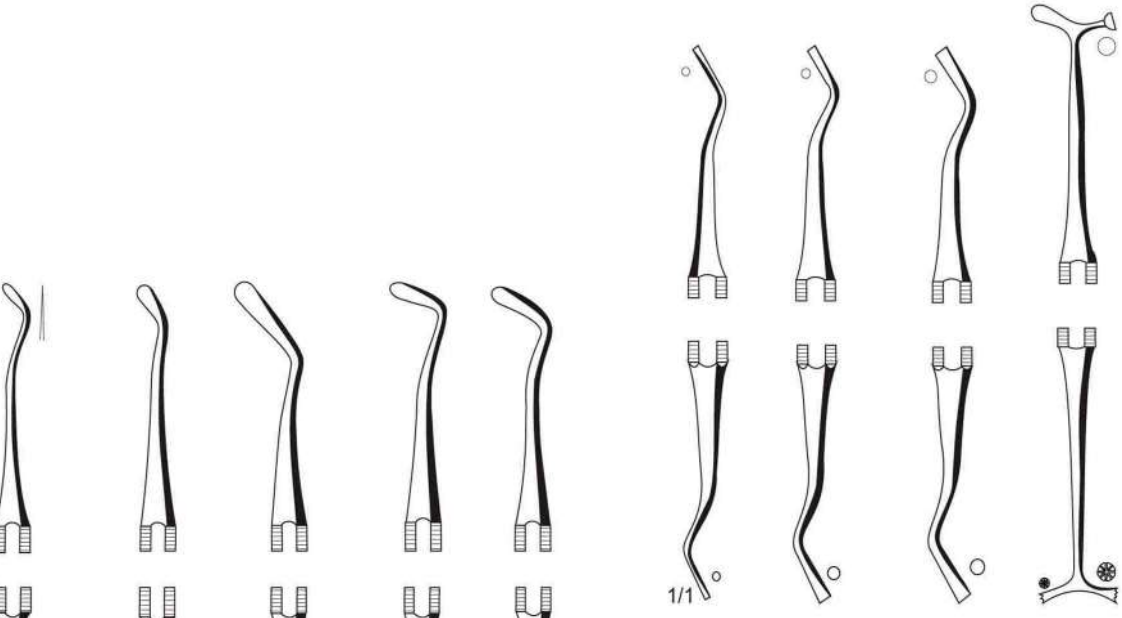

1/1
 Williams
06-1600 Fig.0 **06-1601** Fig.1 **06-1602** Fig.2 **06-1604** Fig.4 **06-1606** Fig.6
06-1700 Fig.0 **06-1701** Fig.1 **06-1702** Fig.2 **06-1703** Fig.3

Please see page 34 for different handle styles.

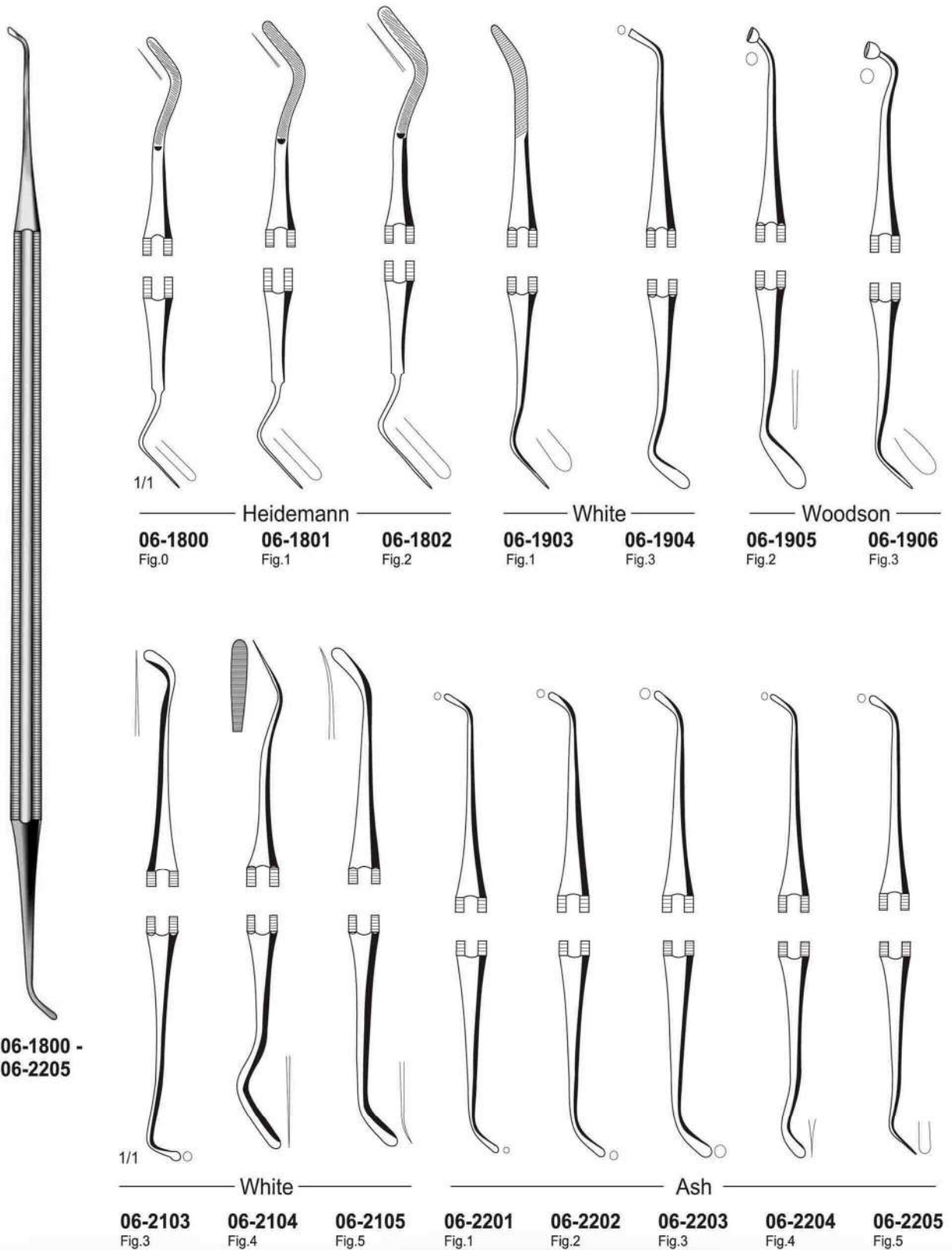

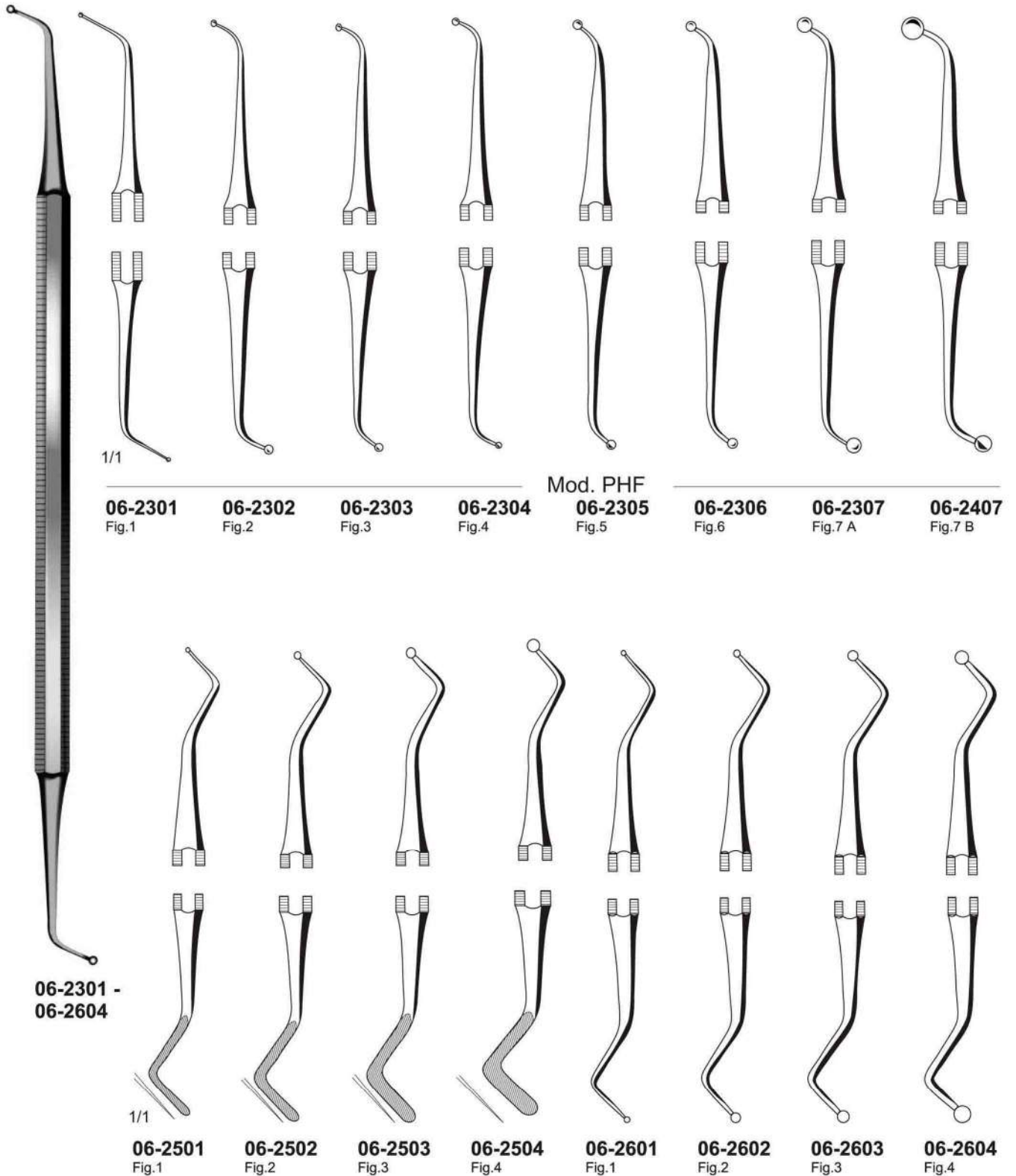

Please see page 34 for different handle styles.

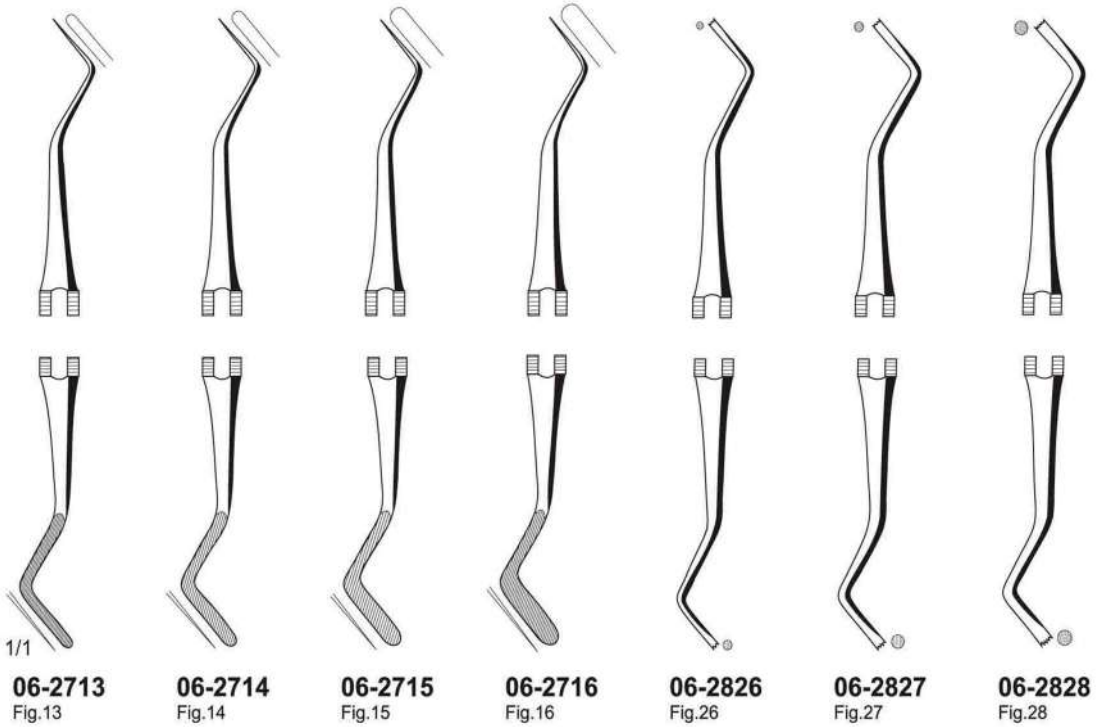
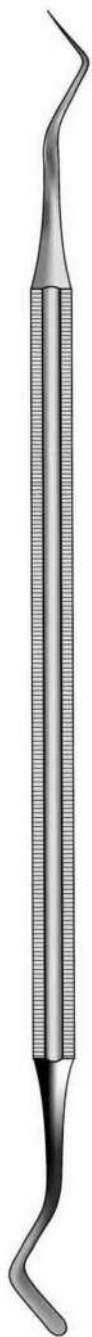

1/1
06-2713
 Fig.13

06-2714
 Fig.14

06-2715
 Fig.15

06-2716
 Fig.16

06-2826
 Fig.26

06-2827
 Fig.27

06-2828
 Fig.28

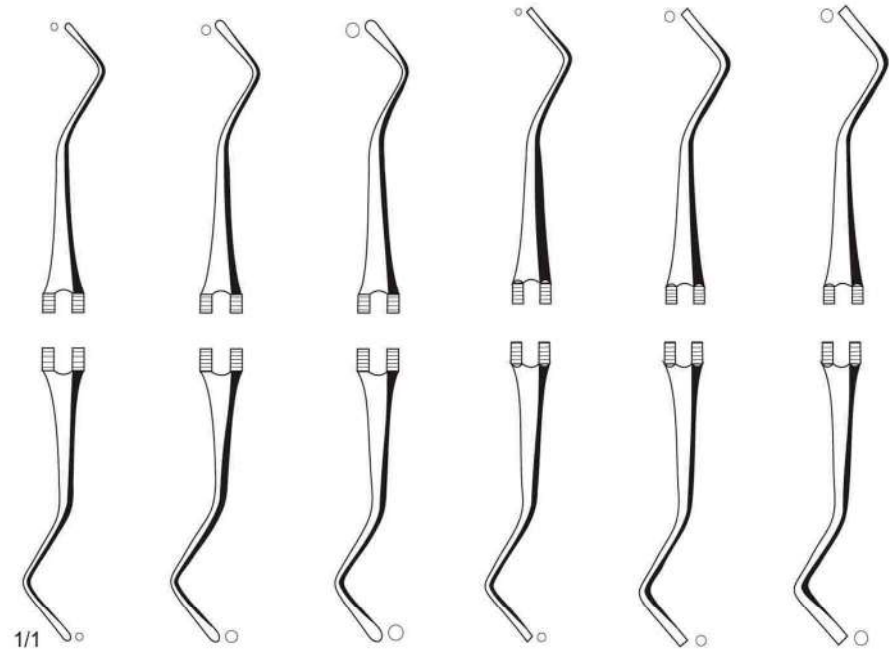

1/1
06-2917
 Fig.17

06-2918
 Fig.18

06-2919
 Fig.19

06-3035
 Fig.35

06-3036
 Fig.36

06-3037
 Fig.37

06-2713 - 06-3037

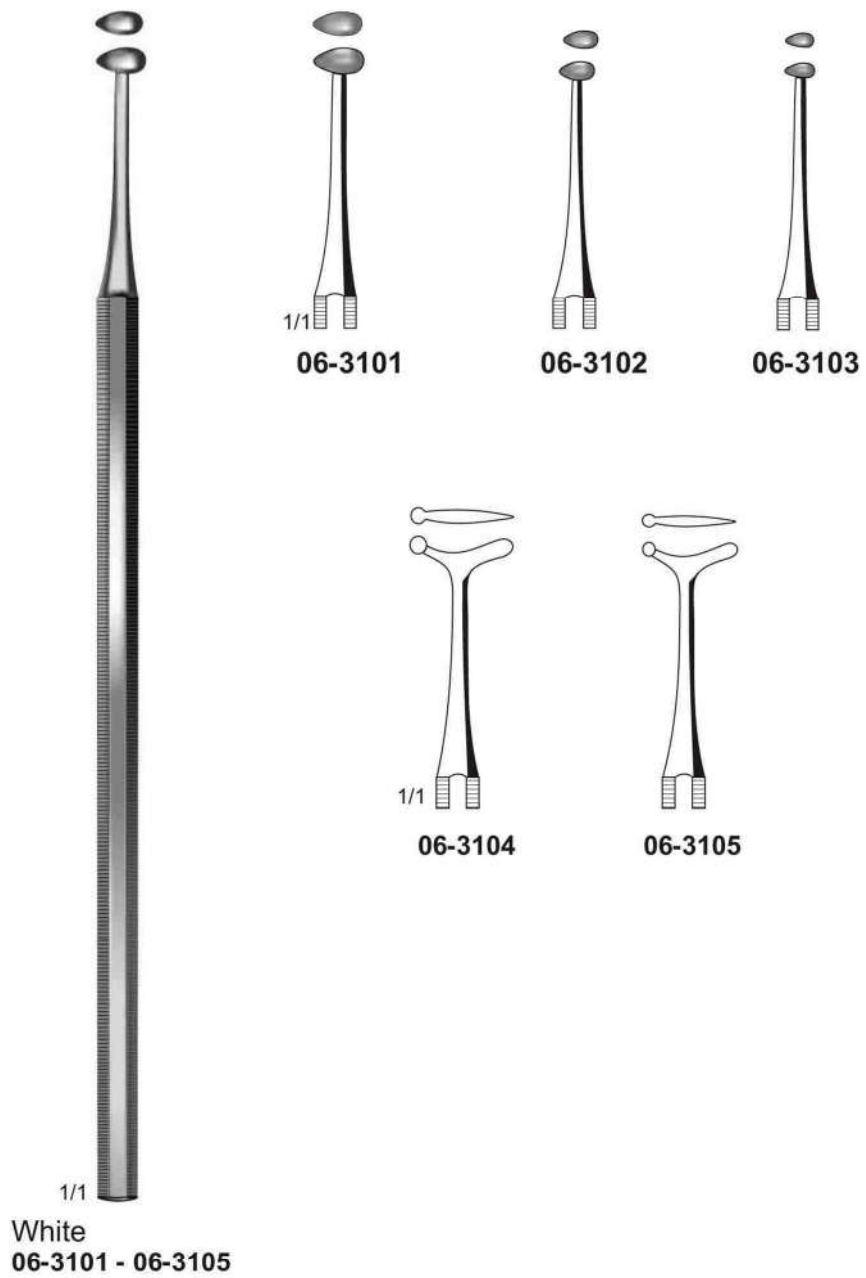

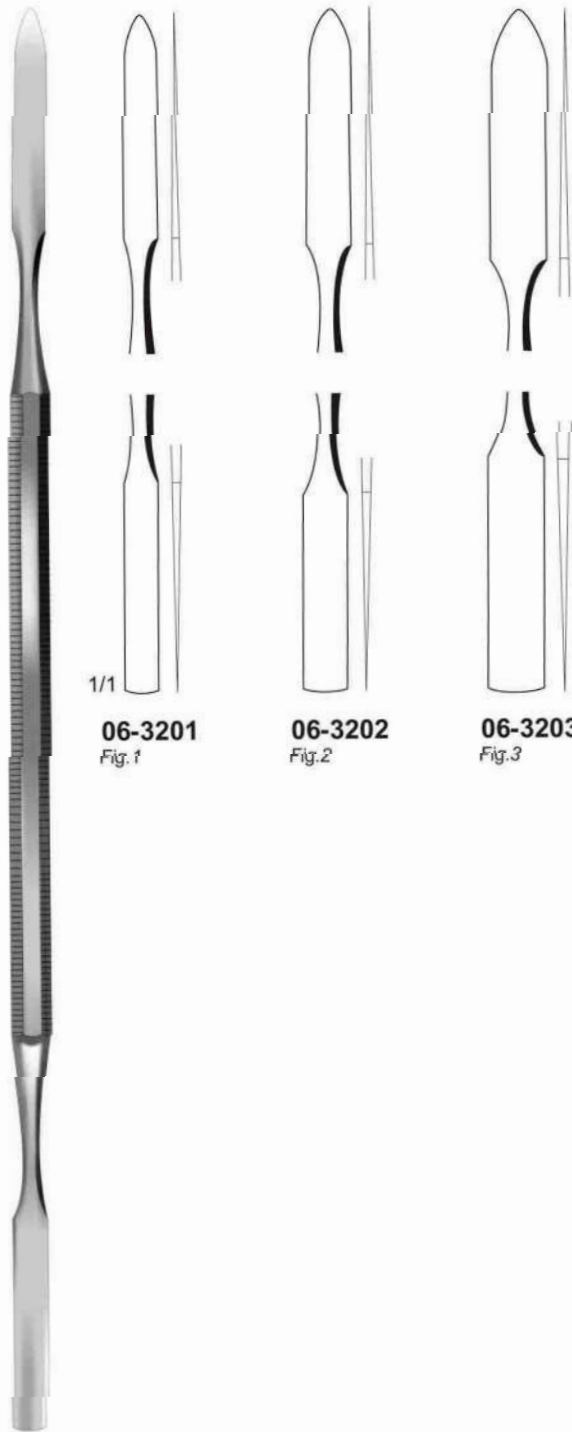

1/1

06-3201
Fig.1

06-3202
Fig.2

06-3203
Fig.3

1/1

06-3201 - 06-3203

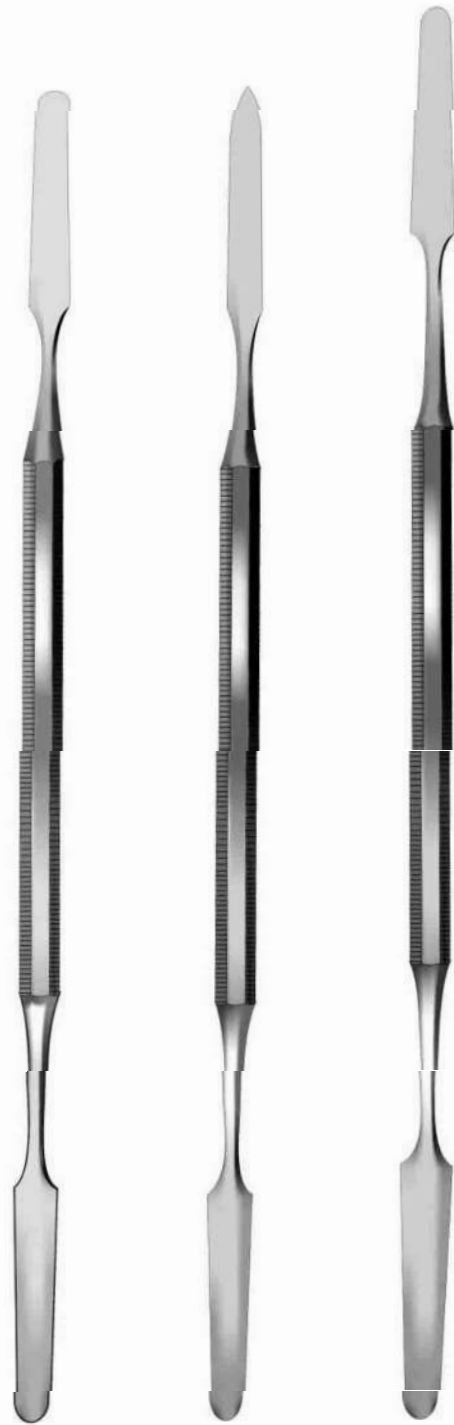

06-3301

06-3302

06-3304





Sclers
Zahnreiniger
Limpiadores de sarro
Instruments a detartre
Scaler

Tel# 0092-52-4260785
Fax# 0092-52-4266804
Email. Info@benison.com.pk



Please see page 34 for different handle styles.

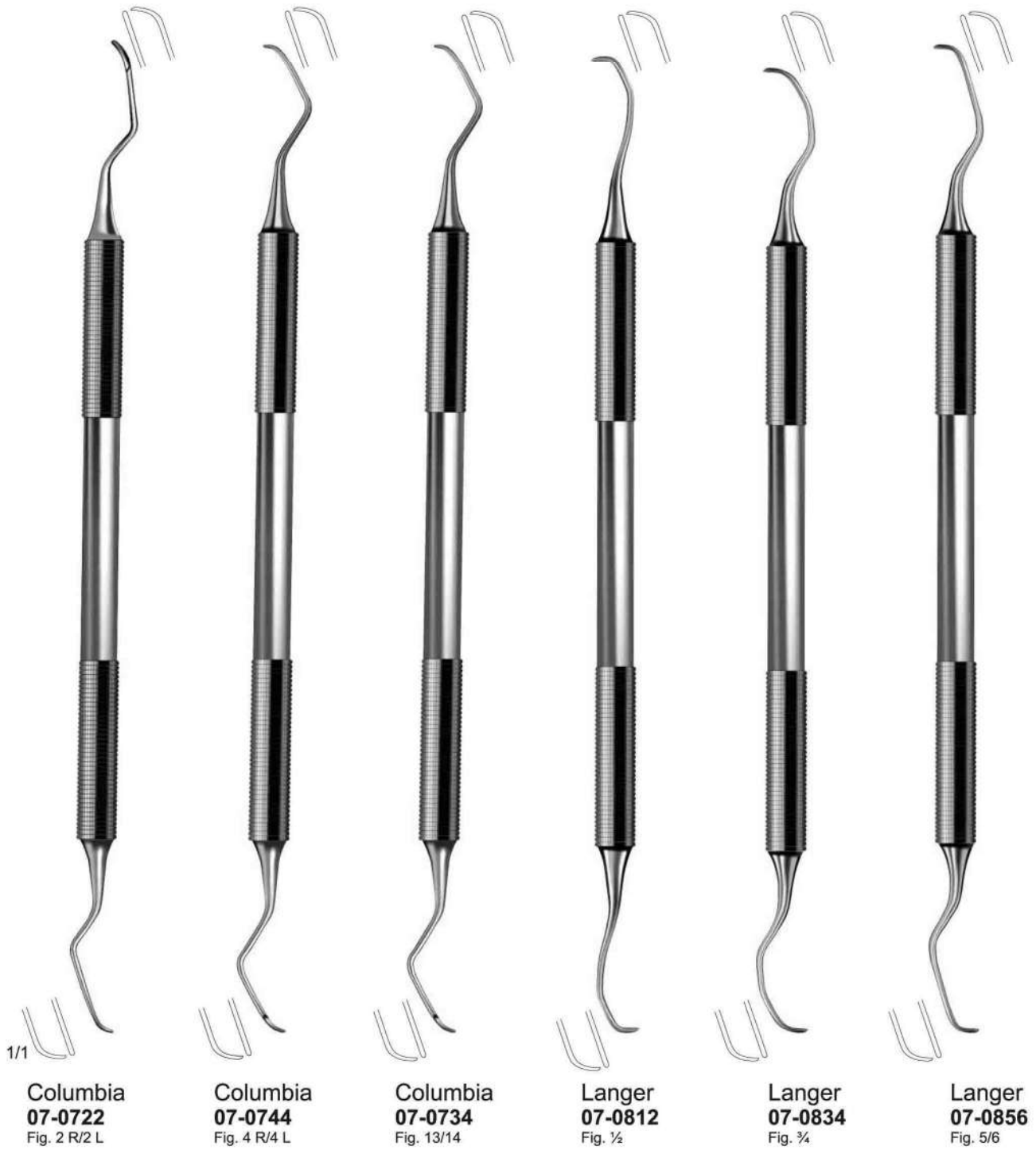



Younger-Good
07-0978
Fig. 7/8

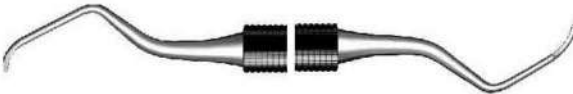

Barnhart
07-1012
Fig. ½



Barnhart
07-1056
Fig. 5/6



Indiana University (Anterior)
07-1134
Fig. 13/14+



Indiana University (Posterior)
07-1178
Fig. 17/18+



Bunting
07-1212
Fig. ½+



Bunting
07-1256
Fig. 5/6

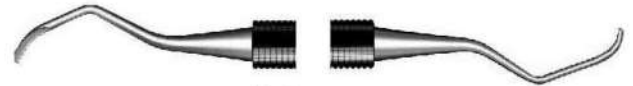

Bates
07-1334
Fig. 135/145

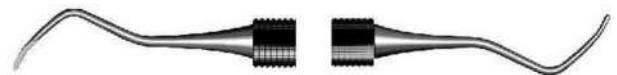

Rule
07-1434
Fig. ¾

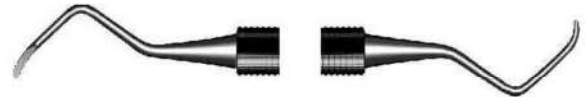

07-1441
Fig. 411/412



07-1541
Fig. 413/414

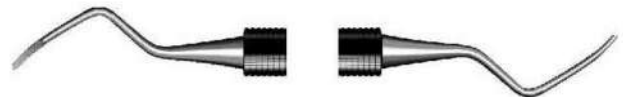

Mallery
07-1612
Fig. ½



Goldman
07-1632
Fig. 31/32



07-1711
Fig. 1



Anterior
07-1812
Fig. ½



Periodantia Instruments
Instrumente zur paradontologie
Instrumentos para periodoncia
Instrument pour la paradontologie
Strumenti per parodontologia

Tel# 0092-52-4260785
Fax# 0092-52-4266804
Email. Info@benison.com.pk

Periodontia Probes



08-0100
Fig. 8



08-0101
Fig. W



08-0108
Fig. 11



08-0110
Fig. 0



08-0111
Fig. 10



08-0112
Fig.WHO



08-0201



08-0301



08-0302

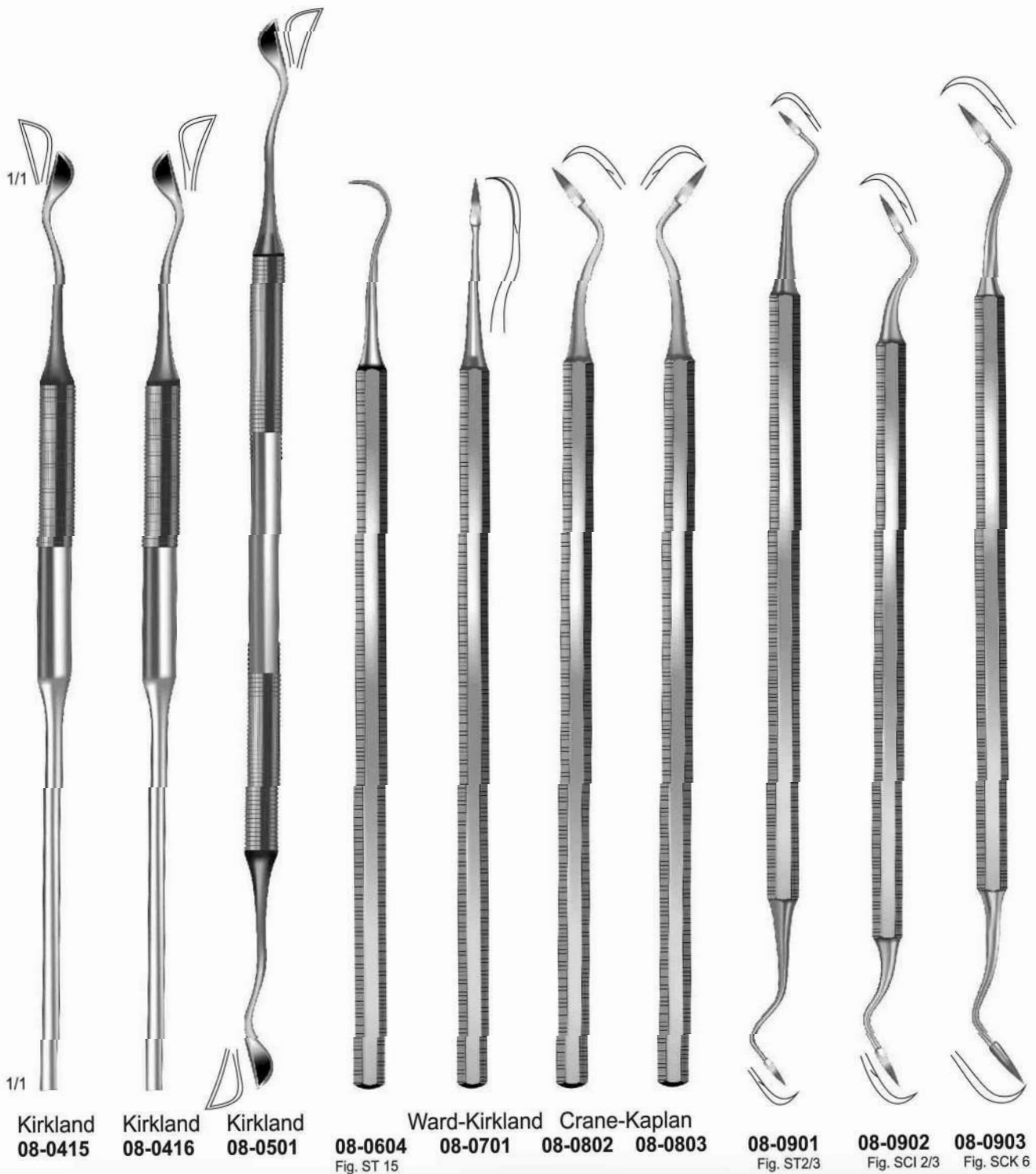

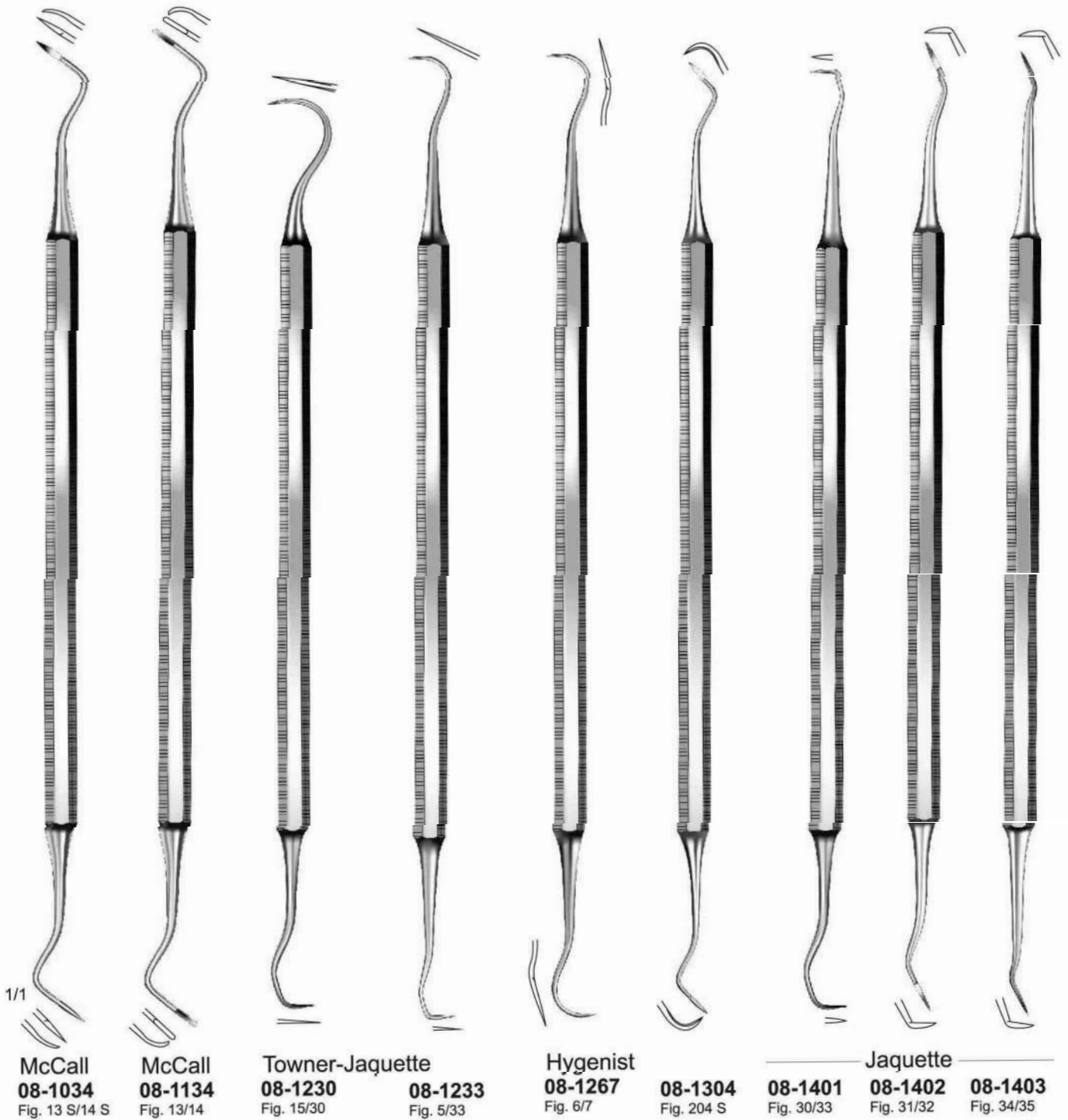

Please see page 34 for different handle styles.

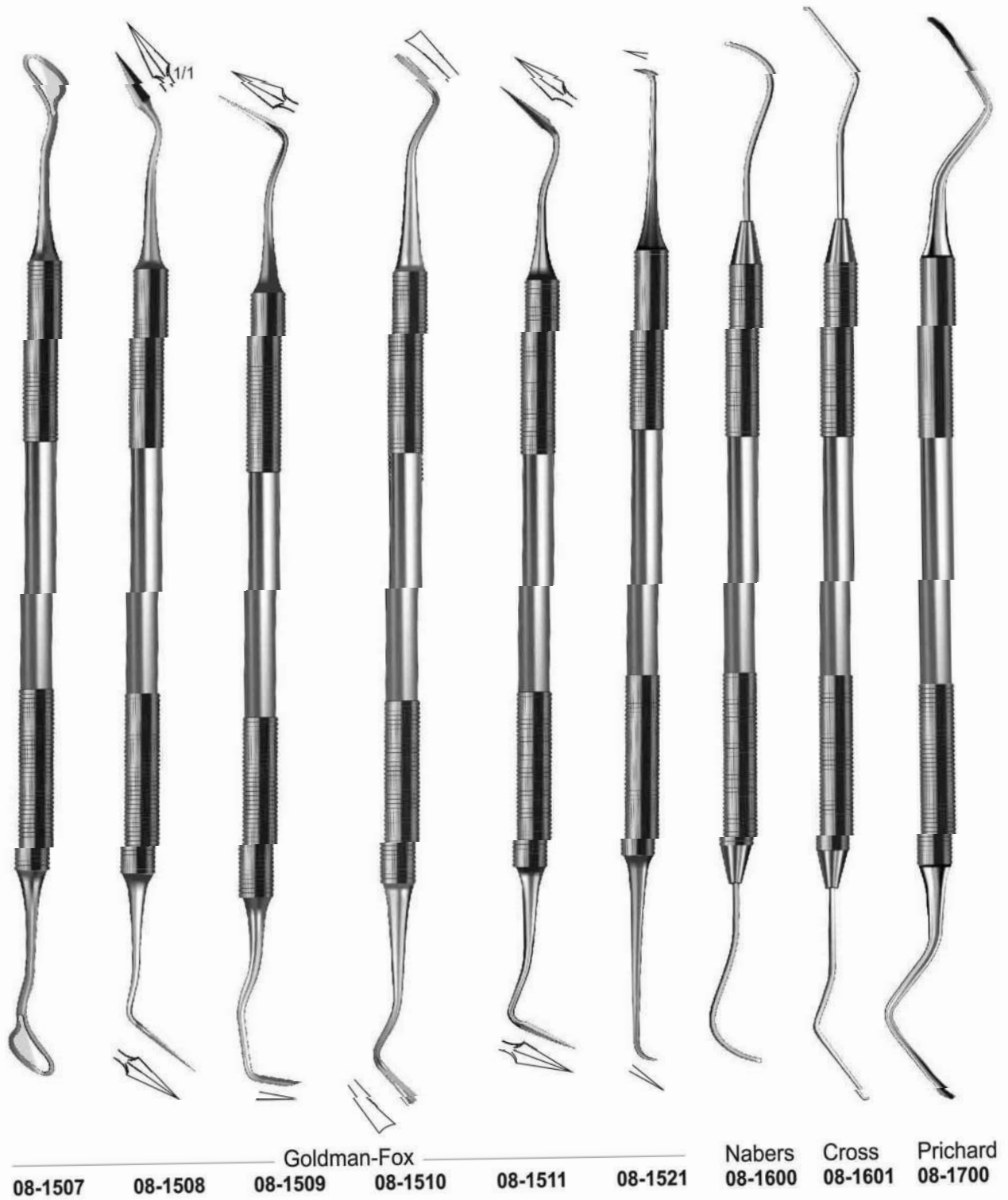

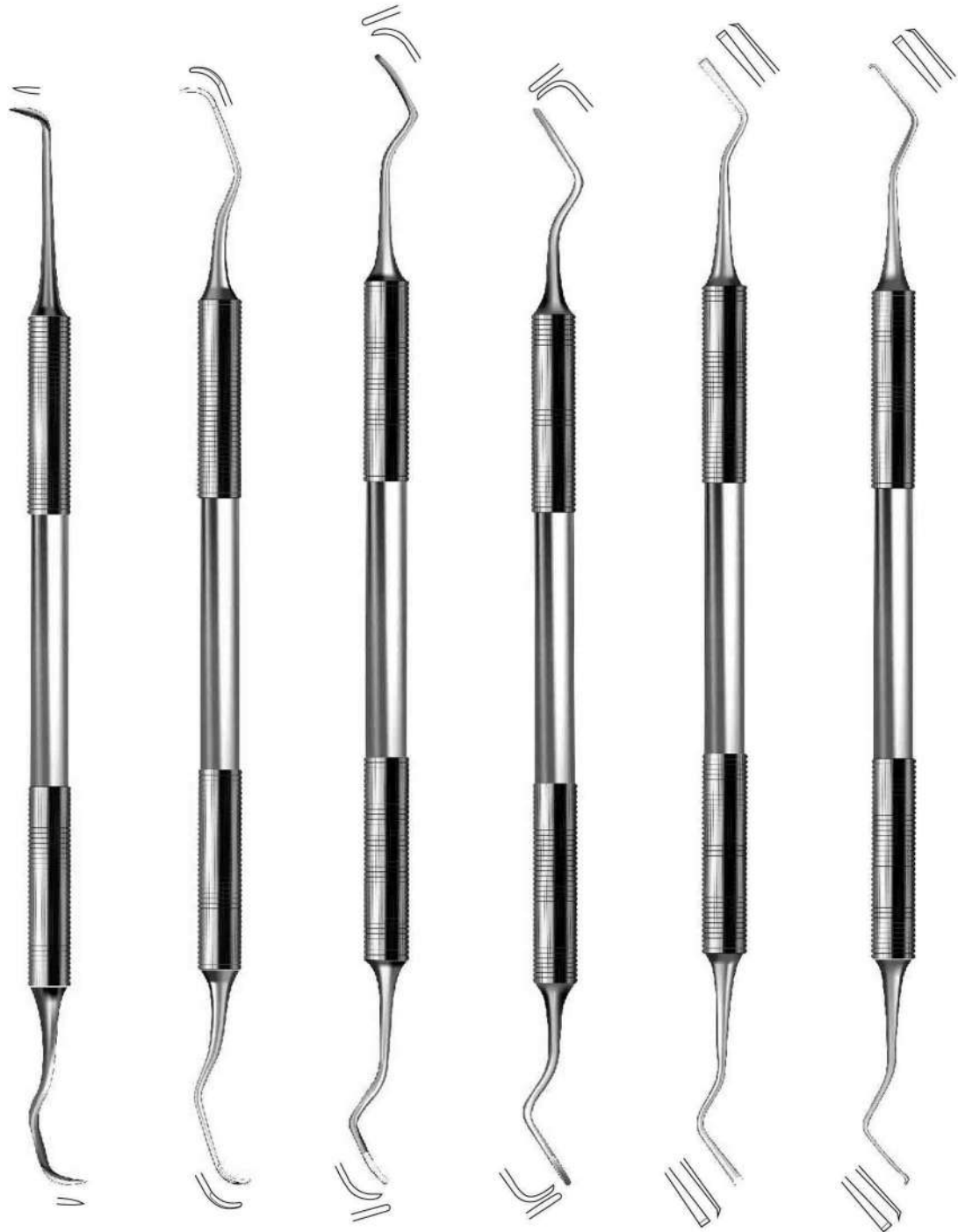

08-2101
16cm/ 6 1/4"

08-2102
16cm/ 6 1/4"

08-2103
16cm/ 6 1/4"

08-2104
16cm/ 6 1/4"

08-2105
16cm/ 6 1/4"

08-2106
16cm/ 6 1/4"

Goldman Fox

Please see page 34 for different handle styles.

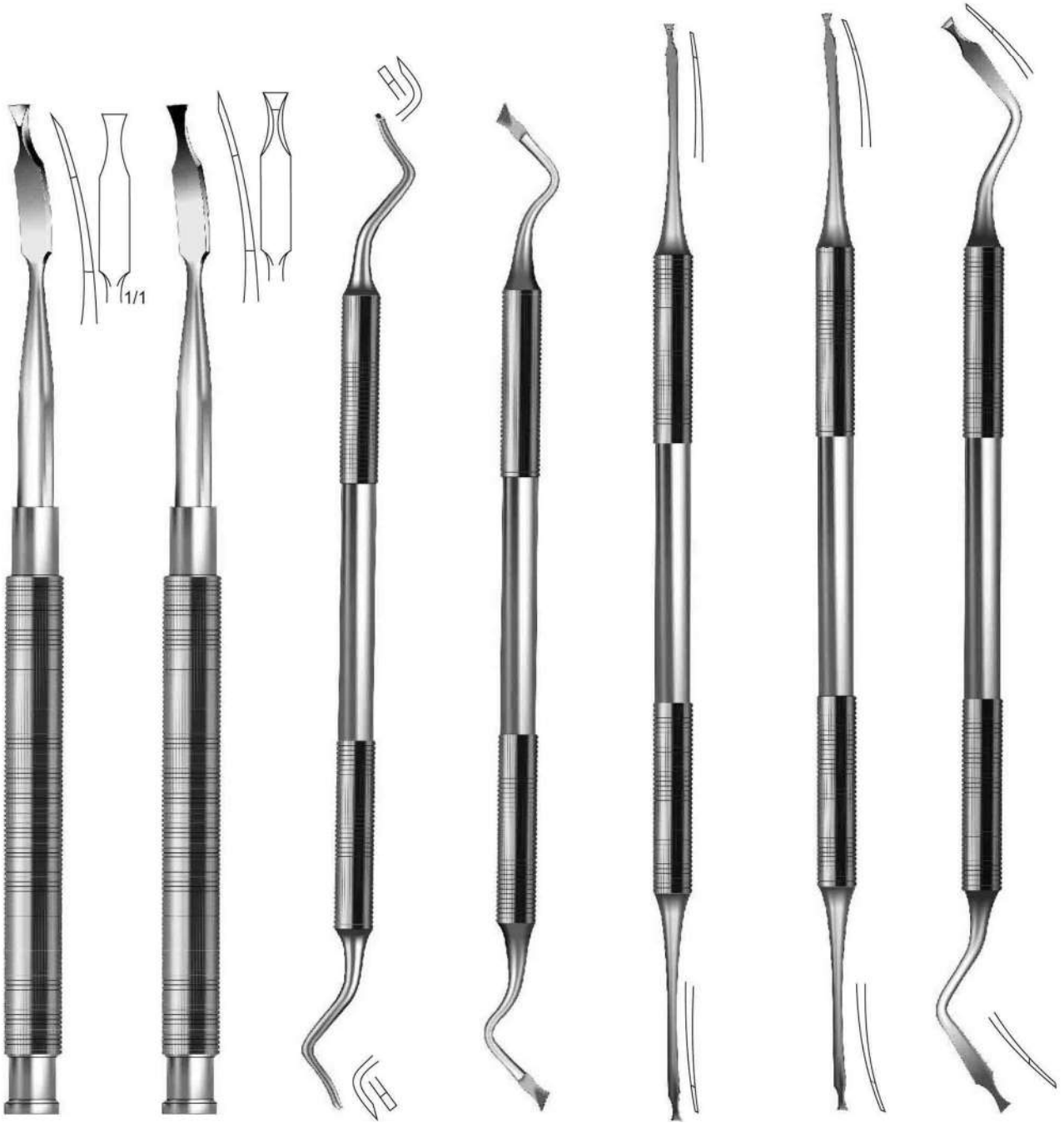

Ochsenbein
08-2201
Fig. 1

Ochsenbein
08-2202
Fig. 2

Ochsenbein
08-2303
Fig. 3

Ochsenbein
08-2304
Fig. 4

Fedi
08-2501
Fig. 1

Fedi
08-2502
Fig. 2

Fedi
08-2503
Fig. 3

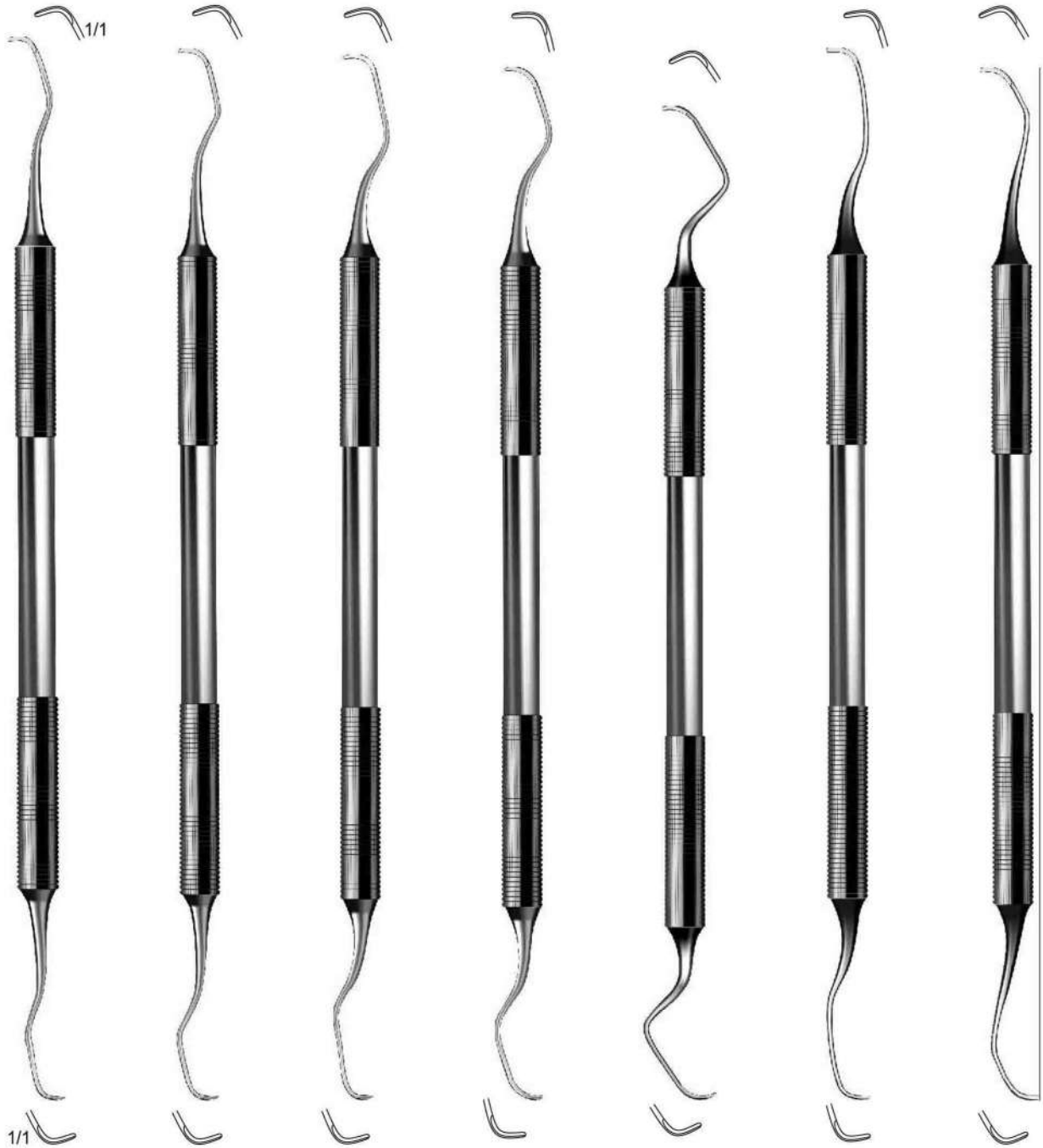

08-2612
Fig. 1/2

08-2634
Fig. 3/4

08-2656
Fig. 5/6

Gracey
08-2678
Fig. 7/8

08-2690
Fig. 9/10

08-2692
Fig. 11/12

08-2694
Fig. 13/14

Please see page 34 for different handle styles.



Excavator, Probes & Explorer, Nerve Instruments
Excavatoren, Zahnsonden Nervinstrumente
,Excavadores, sondas y exploradores
Instrumentos para nervios
Excavateurs, Sondes, et exploreurs
Escavatori, Sonde, Strumenti per nervi

Tel# 0092-52-4260785
Fax# 0092-52-4266804
Email. Info@benison.com.pk

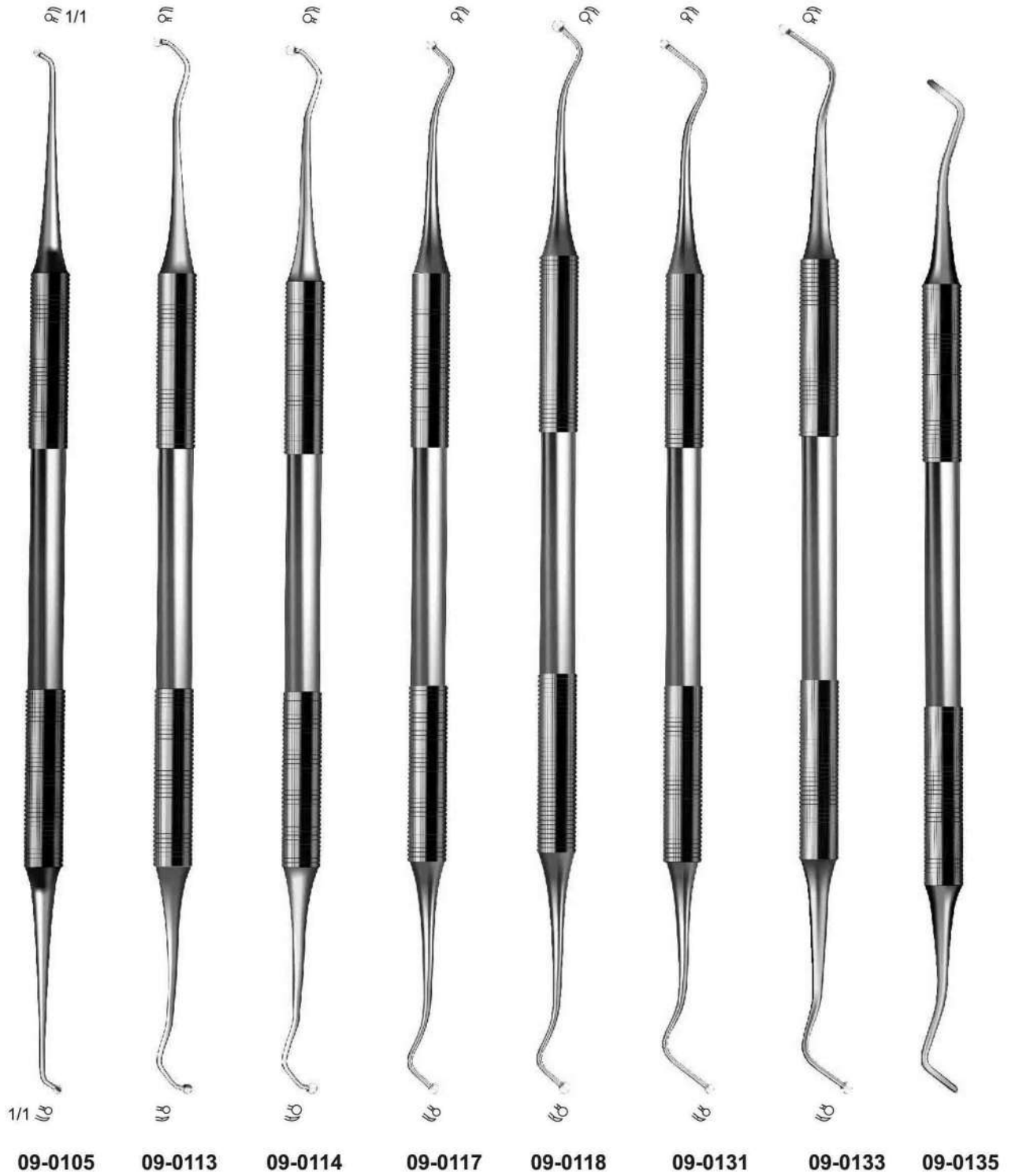

Please see page 34 for different handle styles.

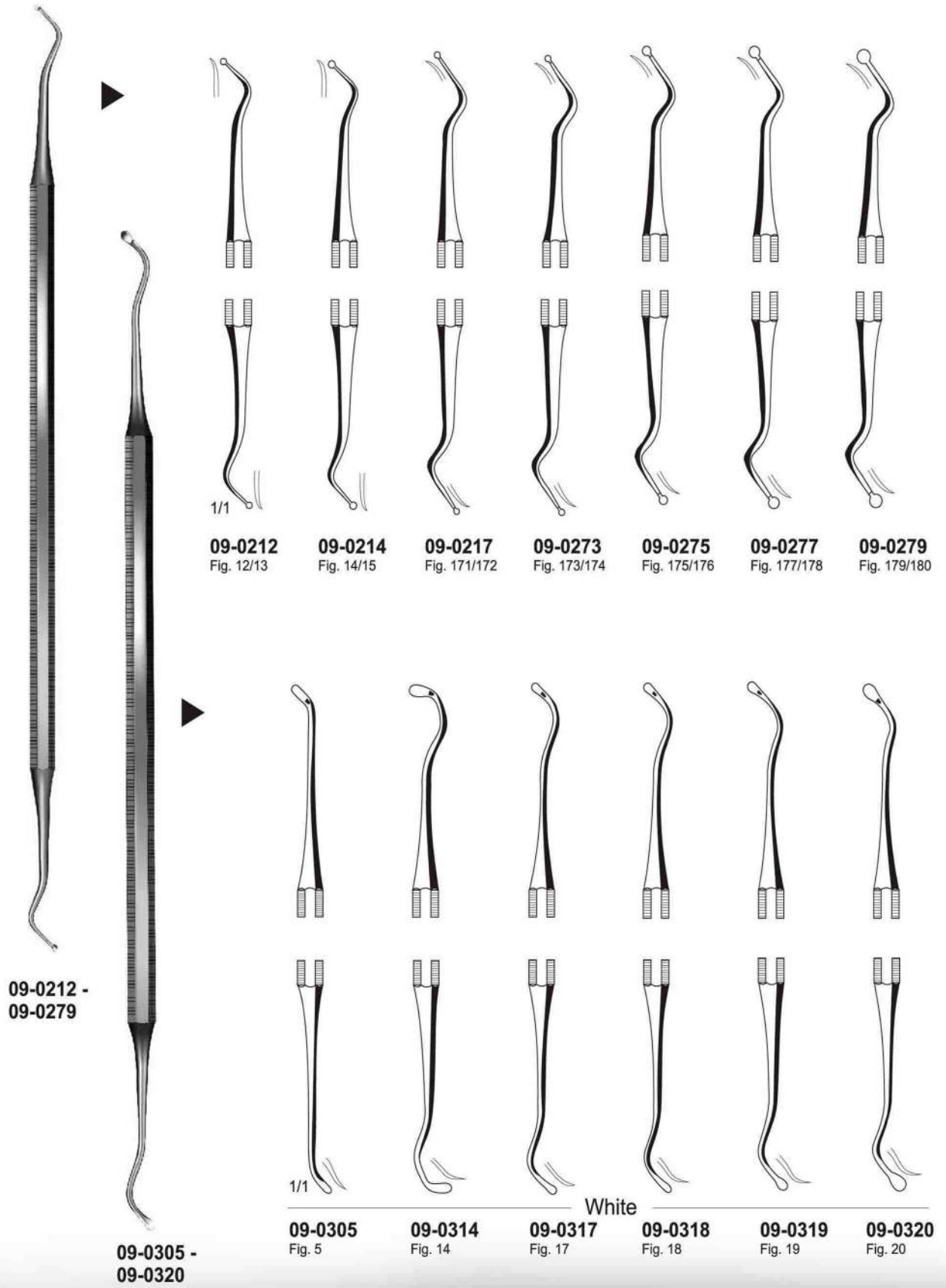

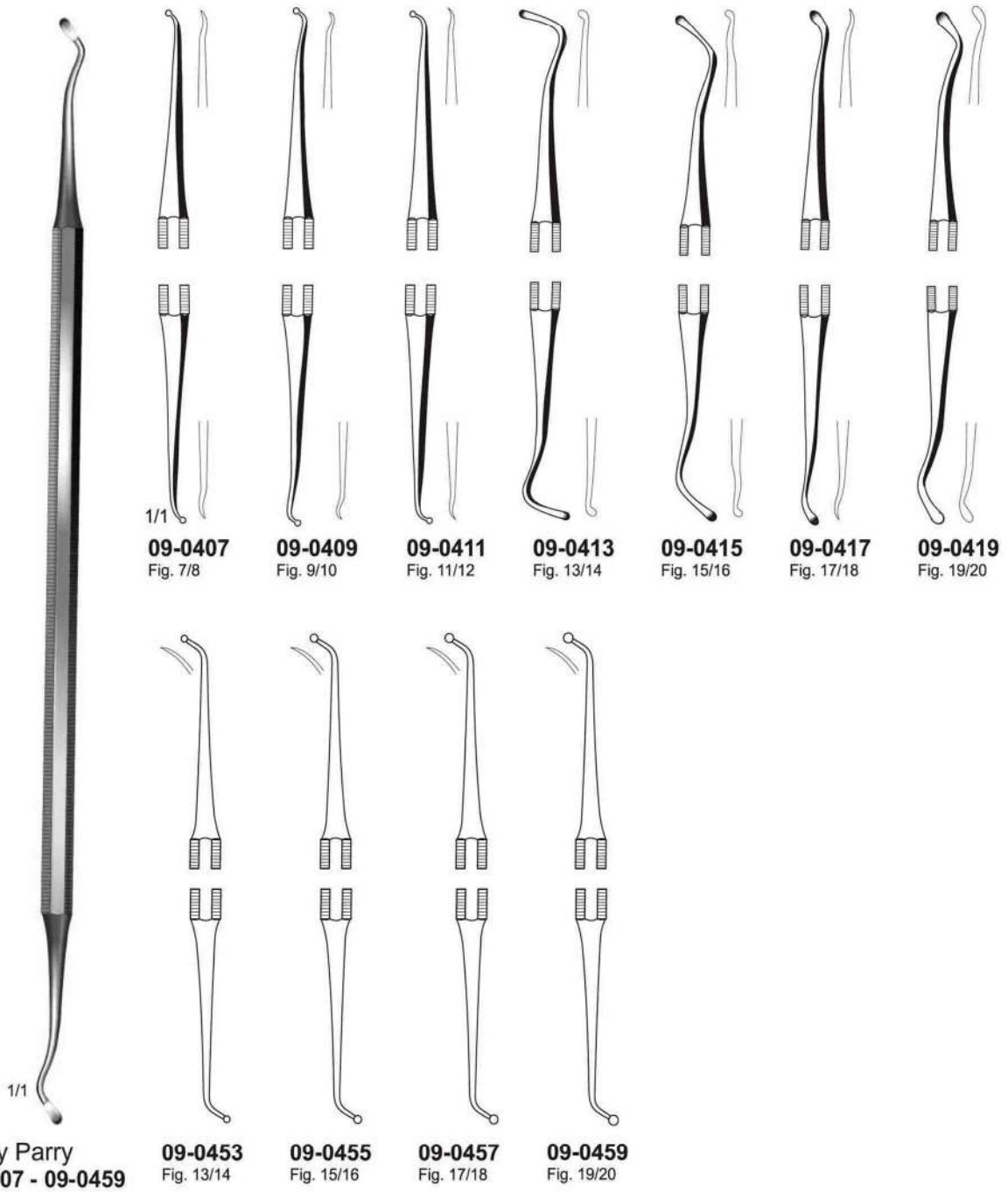



**09-0503-
09-0525**



09-0503
Fig. 3/4

09-0505
Fig. 5/6

09-0507
Fig. 7/8

09-0509
Fig. 9/10

09-0511
Fig. 11/12

09-0513
Fig. 13/14

09-0515
Fig. 15/16

09-0517
Fig 17/18

09-0519
Fig 19/20

09-0521
Fig 21/22

09-0523
Fig 23/24

09-0525
Fig 25/26

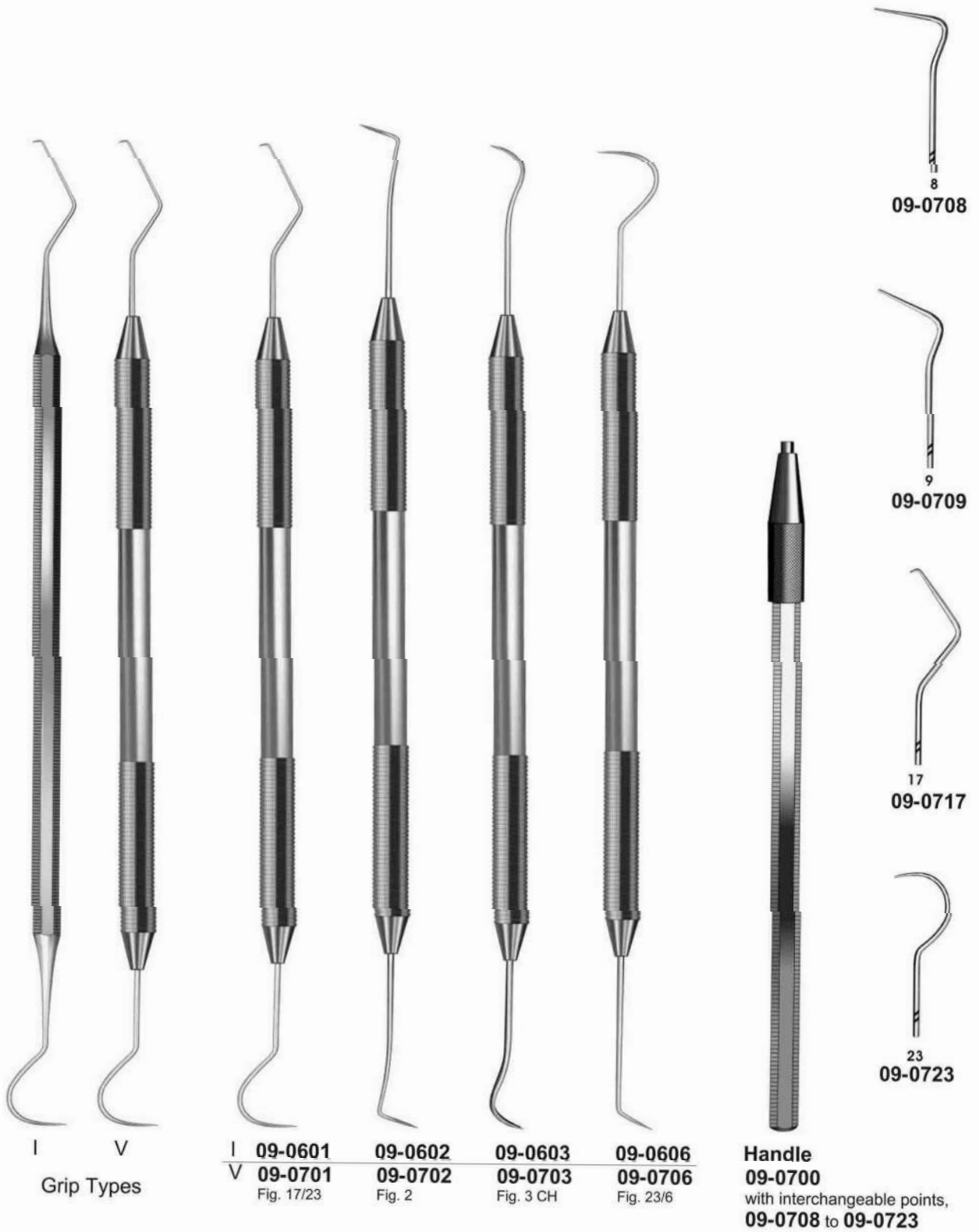

I V
Grip Types

I	09-0601	09-0602	09-0603	09-0606
V	09-0701	09-0702	09-0703	09-0706
	Fig. 17/23	Fig. 2	Fig. 3 CH	Fig. 23/6

Handle
09-0700
with interchangeable points,
09-0708 to 09-0723

Please see page 34 for different handle styles.

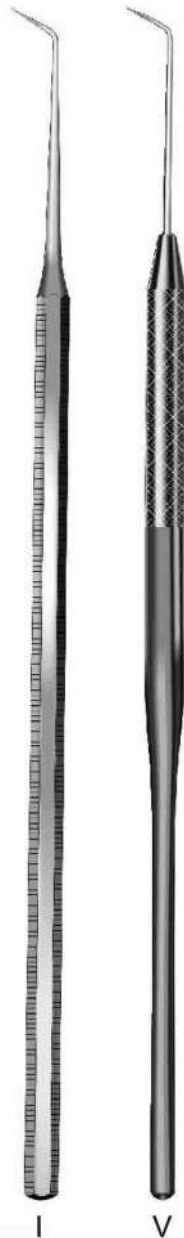
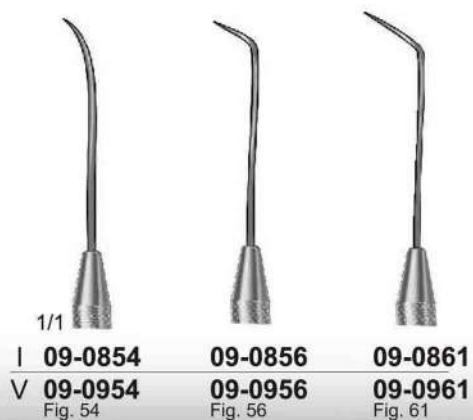
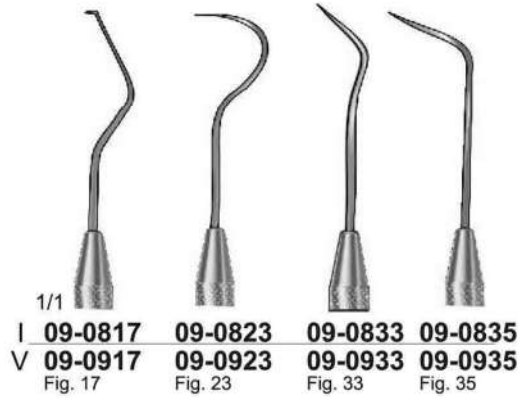
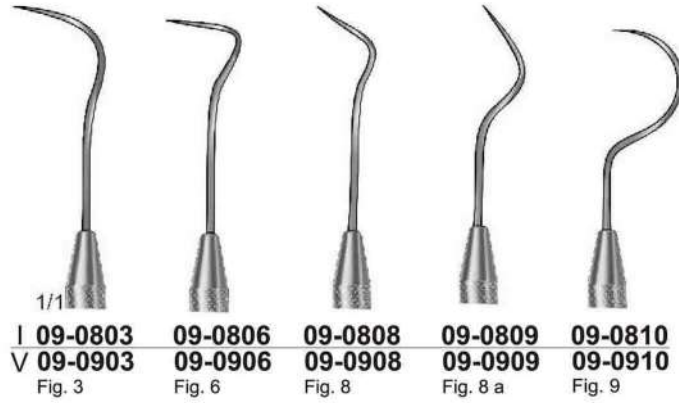

Grip Types

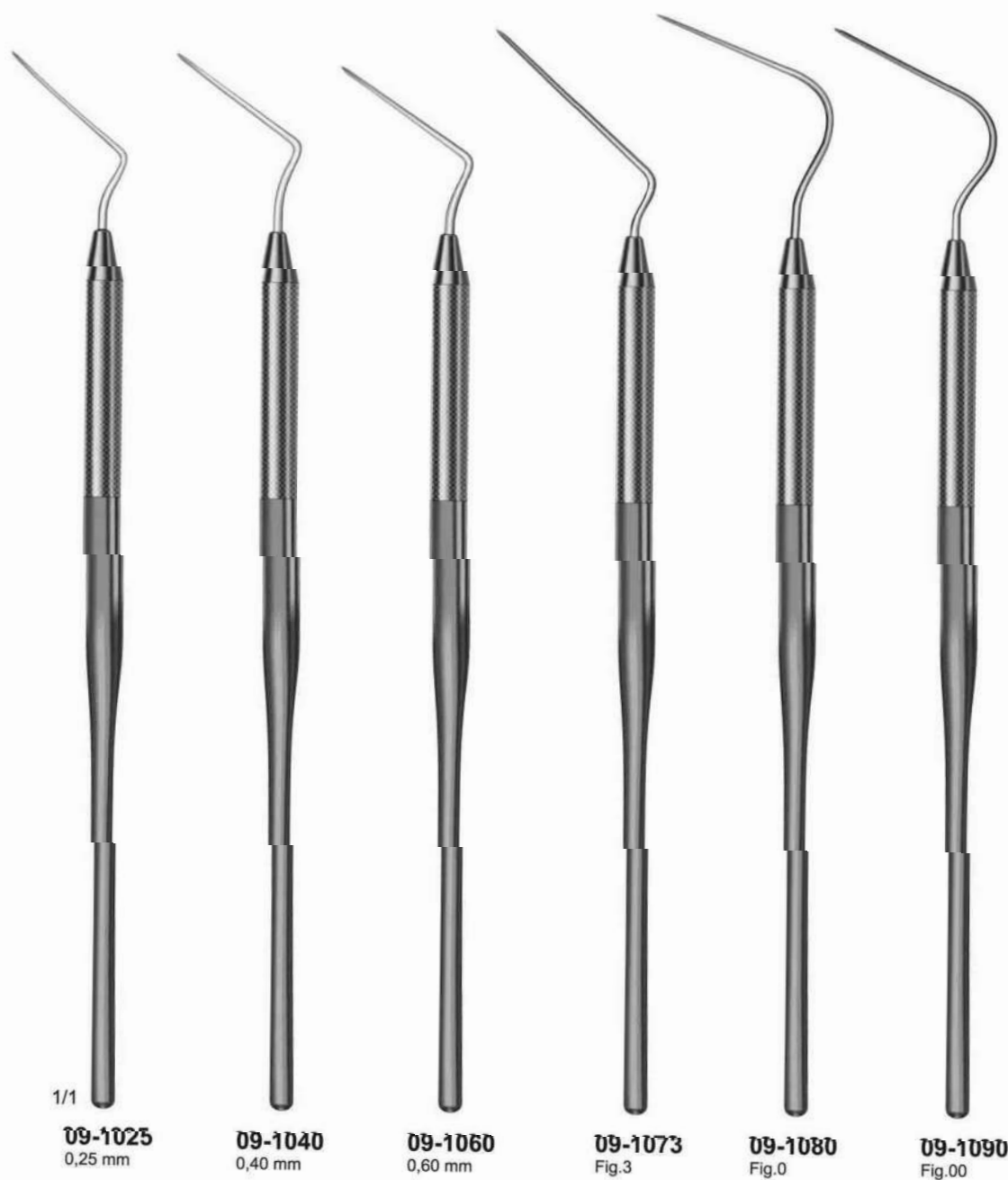

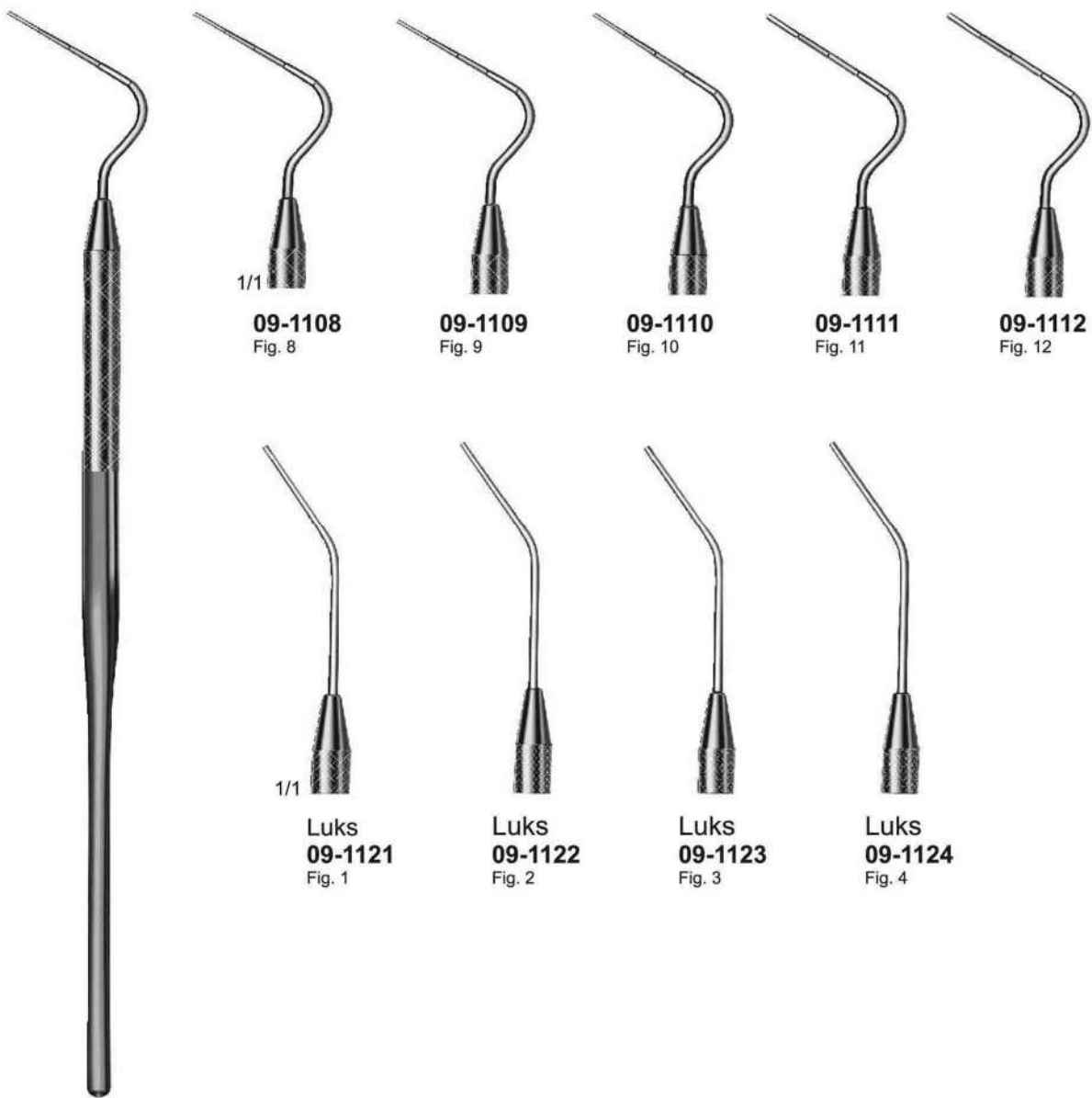

Luks
09-1108-09-1124

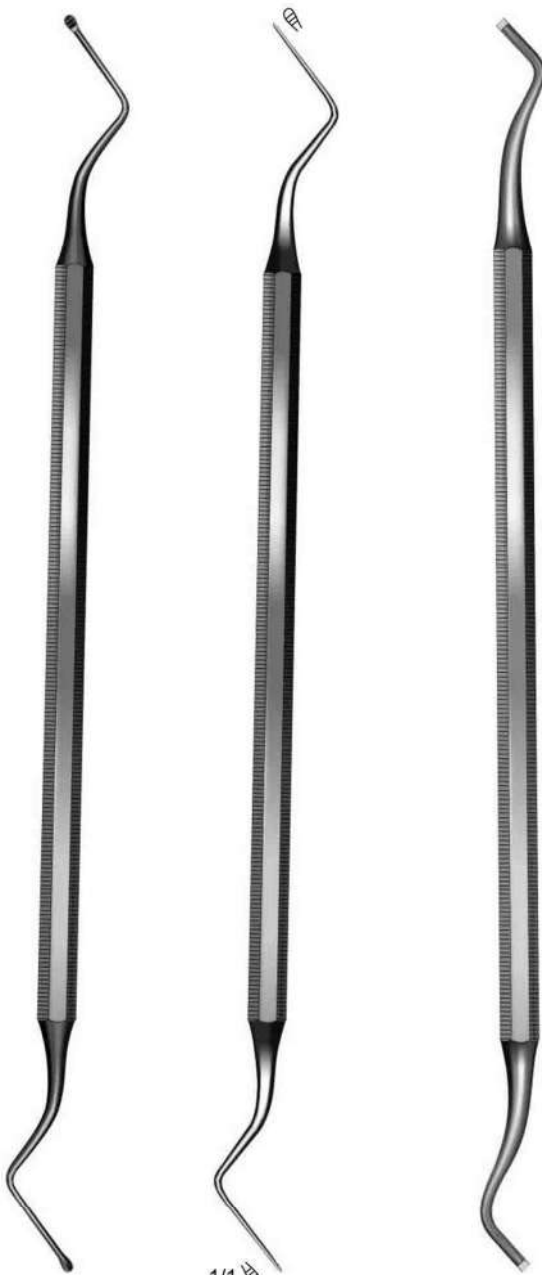

Hirschfeld
09-1237
 Fig. 3/7

1/1 
 Hirschfeld
09-1211
 Fig. 5/11

Black
09-1351 - 09-1379

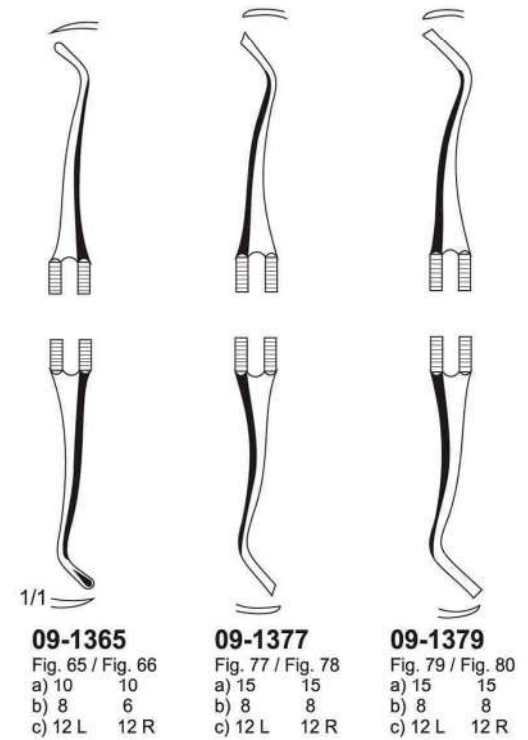
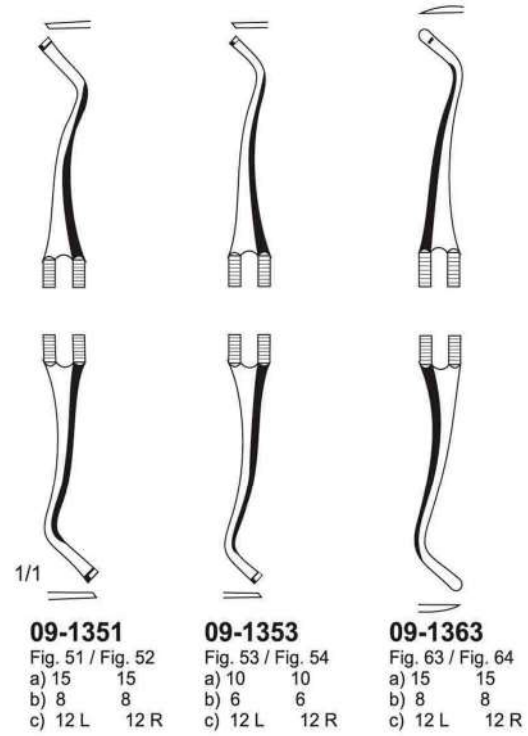

a) Width of blade in 1/10 mm
 b) Length of blade from the centre of angle in mm
 c) Angle of blade to its handle in centigrade



Wax and Crown Instruments, Matrix Instrument
Wachs-K,oneninstrumente,
Matrizen-Instrumente
Instrumentose para cera, coronas,
Instrumentos para matrices
instruments pour couonnes et matrices
Strumenti per cera e per corone,
Strumenti per matrici

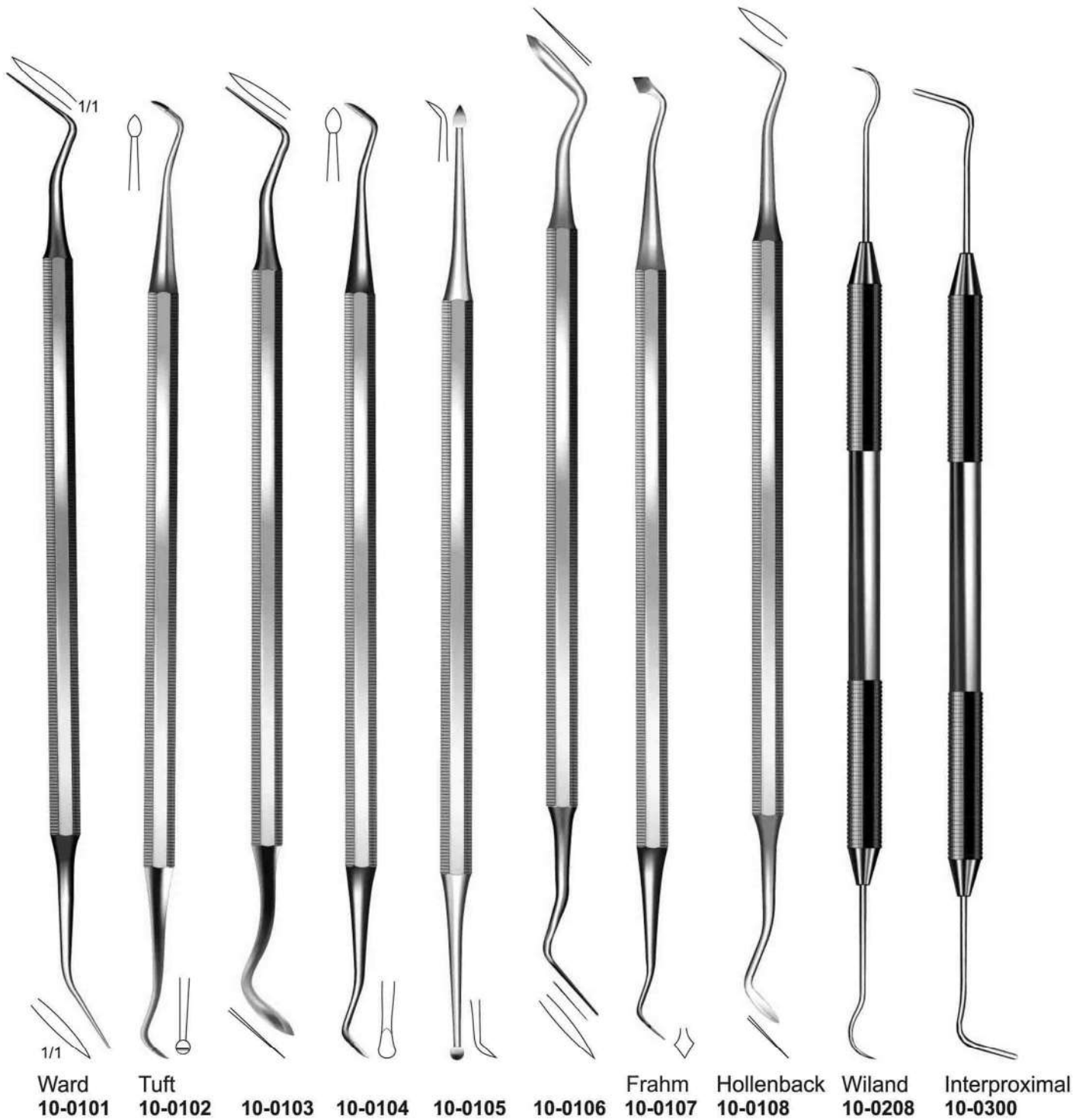



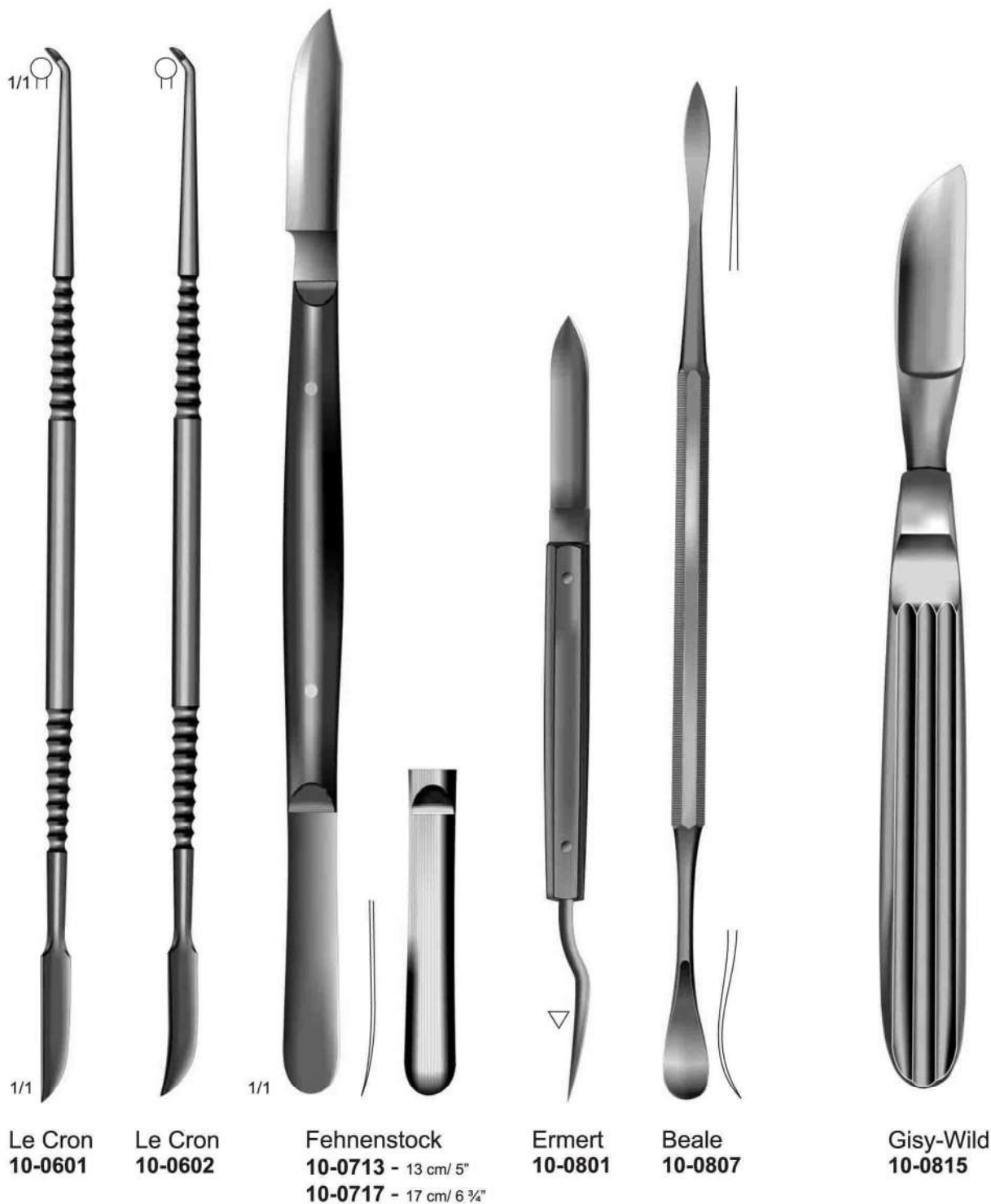



Miller
10-0915



Sachs
10-1001



Mershon
10-1101



10-1201



10-1301

10-1302

10-1303

10-1304

10-1305



Treyemann
10-1306



Schroeder
10-1300
with interchangeable
points 10-1301-10-1305



10-1307

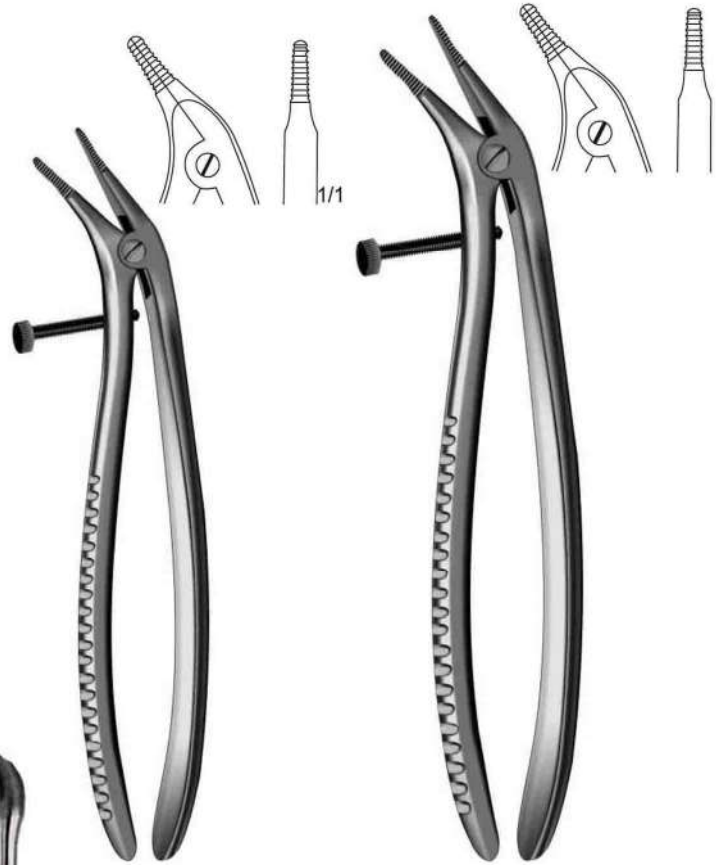

Bohm
10-1511
11.5 cm/ 4½"

Bohm
10-1514
11.5 cm/ 4½"



10-1401

10-1402

10-1403



10-1401 - 10-1403



10-1600 10-1601 10-1602
(Handle for
10-1600-10-1602)



10-1800

For Molars

For Molars and Premolars



1/1
Tofflemire-Universal
10-1905



10-1907
Fig. 7



10-1908
Fig. 8



10-1909
Fig. 9



10-1910
Fig. 10



10-1911
Fig. 1



10-1912
Fig. 12



10-1913
Fig. 13

(Package of 12 bands)



1/1
Ivory
10-2005 - 5 mm
10-2006 - 6 mm
10-2007 - 7 mm



Tofflemire
10-2101
Fig. 1



Tofflemire
10-2102
Fig. 2

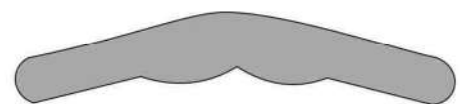

Tofflemire
10-2103
Fig. 3



Tofflemire
10-2104
Fig. 4



1/1
Ivory
10-2201
Fig. 1
(Without shield)

Ivory
10-2212
Fig. 12
(With shield)

Ivory
10-2312
Fig. 12 a

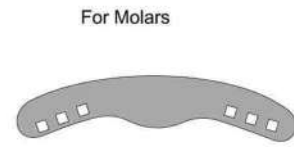

10-2401
Fig. 1



10-2402
Fig. 2



10-2403
Fig. 3

10-2401 - 10-2403

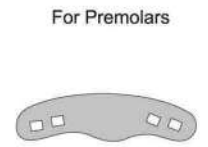

10-2404
Fig. 4



10-2405
Fig. 5



10-2406
Fig. 6

10-2404 - 10-2406



Ainsworth
10-2516
16 cm/6 1/4"

10-2515
15cm/6"

Stocks
10-2617
17 cm/ 6 3/4"

Brewer
10-2717
17 cm/ 6 3/4"

10-2716
16 cm/6 1/4"



Impression Trays
Abdruckloffer
portamoldes
porte-empreintes
Porta-impronte

Tel# 0092-52-4260785
Fax# 0092-52-4266804
Email. Info@benison.com.pk

Stainless Steel

INOX
18/08

Stainless steel "Solid" impression trays with retention rim.

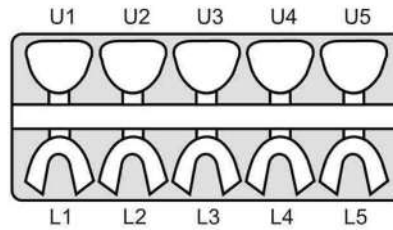

set
10

Set of 10 pieces.
11-2003

For Upper Jaw



		mm.	mm.
11-2051- U1	XL	81	63
11-2052- U2	L	74	60
11-2053- U3	M	71	55
11-2054- U4	NM	67	53
11-2055- U5	S	65	51

For Lower Jaw



		mm.	mm.
11-2061- L1	XL	80	63
11-2062- L2	L	78	59
11-2063- L3	M	76	57
11-2064- L4	NM	72	57
11-2065- L5	S	69	50

Stainless steel "Perforated" impression trays
with retention rim.

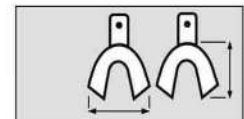
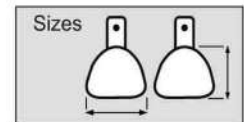

For Upper Jaw

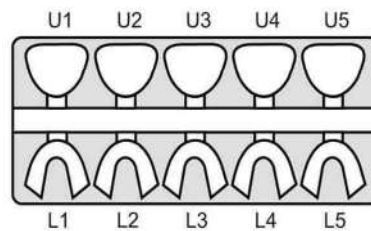

set
10

Set of 10 pieces.
11-2103



		mm.	mm.
11-2151- U1	XL	81	63
11-2152- U2	L	74	60
11-2153- U3	M	71	55
11-2154- U4	NM	67	53
11-2155- U5	S	65	51

For Lower Jaw



		mm.	mm.
11-2161- L1	XL	80	63
11-2162- L2	L	78	59
11-2163- L3	M	76	57
11-2164- L4	NM	72	57
11-2165- L5	S	69	50

Stainless Steel

INOX
18/08

Stainless steel "Solid" impression trays with retention rim.

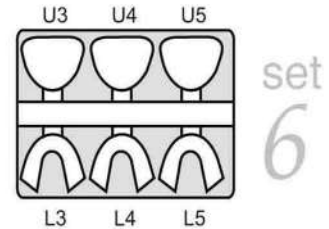

Set of 6 pieces.
11-2301

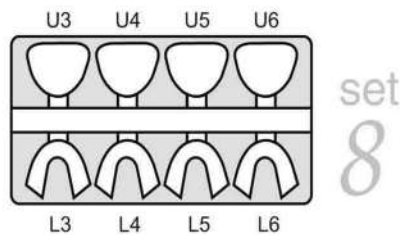

Set of 8 pieces.
11-2302

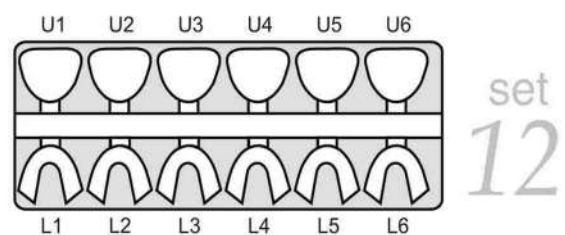

Set of 12 pieces.
11-2304

For Upper Jaw

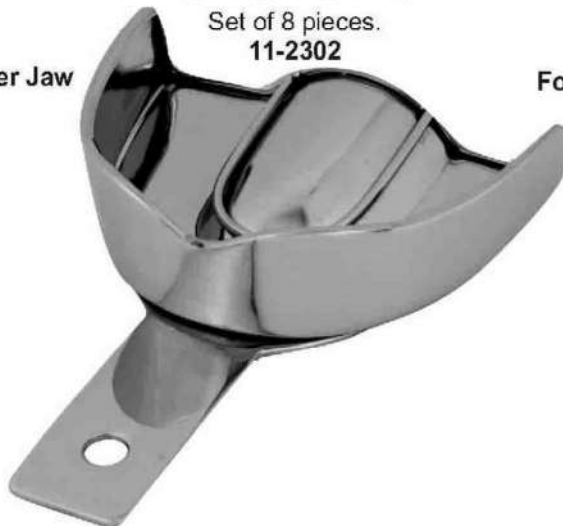

For Lower Jaw



			mm.	mm.
11-2311- U1	XXS	61	47	
11-2312- U2	XS	64	51	
11-2313- U3	S	66	53	
11-2314- U4	M	69	57	
11-2315- U5	L	71	60	
11-2316- U6	XL	73	62	

			mm.	mm.
11-2331- L1	XXS	55	47	
11-2332- L2	XS	60	49	
11-2333- L3	S	72	54	
11-2334- L4	M	74	57	
11-2335- L5	L	76	59	
11-2336- L6	XL	78	61	

Partial impression trays for crown and bridge work.



11-2361- U1P



11-2362- L1P



11-2342- L2D



11-2352- L2S

11-2344- L4D

11-2354- L4S

11-2346- L6D

11-2356- L6S

Stainless steel "Perforated"
impression trays with retention rim.

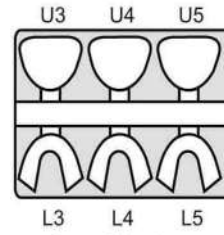

set
6

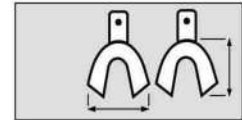
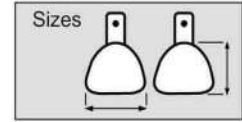

Set of 6 pieces.
11-2401

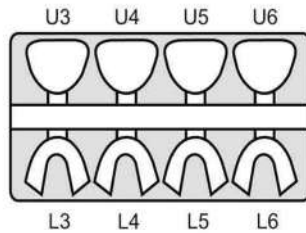

set
8

Set of 8 pieces.
11-2402

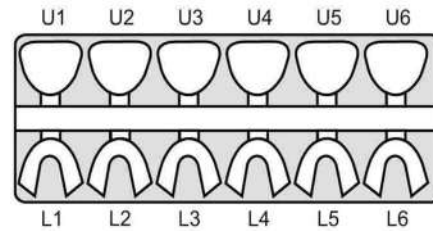

set
12

Set of 12 pieces.
11-2404

For Upper Jaw

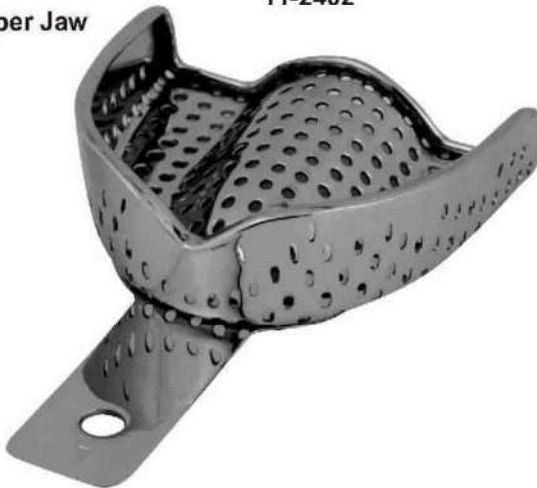

For Lower Jaw



			mm.	mm.
11-2411-	U1	XXS	61	47
11-2412-	U2	XS	64	51
11-2413-	U3	S	66	53
11-2414-	U4	M	69	57
11-2415-	U5	L	71	60
11-2416-	U6	XL	73	62

			mm.	mm.
11-2431-	L1	XXS	55	47
11-2432-	L2	XS	60	49
11-2433-	L3	S	72	54
11-2434-	L4	M	74	57
11-2435-	L5	L	76	59
11-2436-	L6	XL	78	61

Partial impression trays for crown
and bridge work.



11-2461- U1P



11-2462- L1P



11-2442- L2D
11-2444- L4D
11-2446- L6D



11-2452- L2S
11-2454- L4S
11-2456- L6S

Stainless Steel

INOX
18/08

Anteriorly depressed with retention rim.
Stainless Steel "Solid"

"Solid" stainless steel

For Upper Jaw

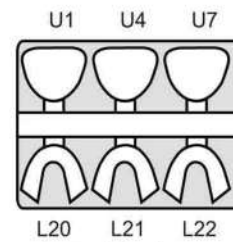

set
6

Set of 6 pieces.
11-2601

		mm.	mm.
11-2611- U1	L	81	67
11-2614- U4	M	71	64
11-2617- U7	S	70	57

For Lower Jaw



		mm.	mm.
11-2631- L20	L	81	60
11-2634- L21	M	79	57
11-2637- L22	S	76	54

Anteriorly depressed with retention rim.
Stainless steel "Perforated"

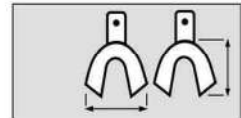
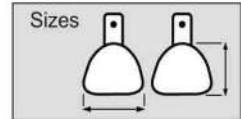

"Perforated" stainless steel

For Upper Jaw

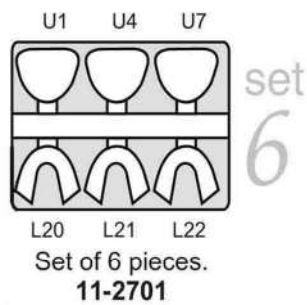

		mm.	mm.
11-2711- U1	L	81	67
11-2714- U4	M	71	64
11-2717- U7	S	70	57

For Lower Jaw



		mm.	mm.
11-2731- L20	L	81	60
11-2734- L21	M	79	57
11-2737- L22	S	76	54

Stainless Steel

INOX
18/08

Stainless steel "Solid" impression trays without retention rim.

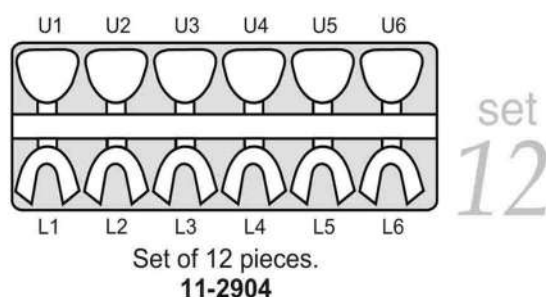
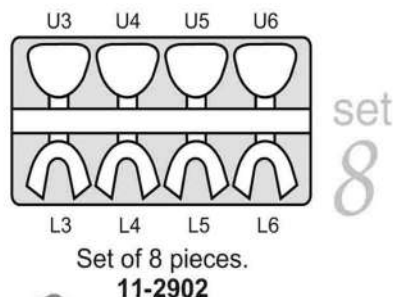
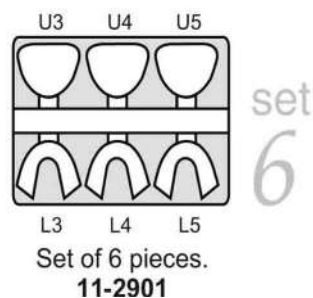

For Upper Jaw

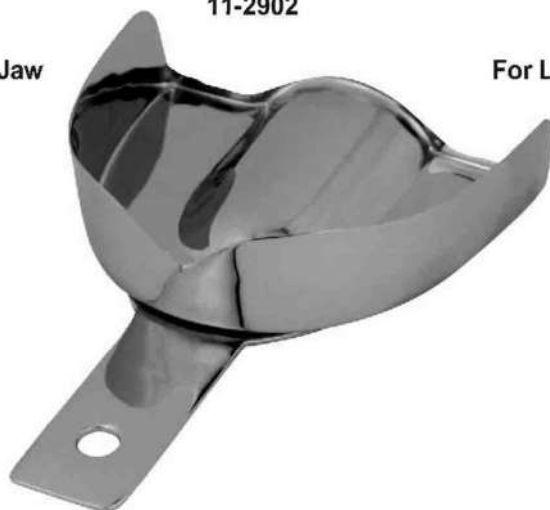

For Lower Jaw



			mm.	mm.
11-2911- U1	XXS	61	47	
11-2912- U2	XS	64	51	
11-2913- U3	S	66	53	
11-2914- U4	M	69	57	
11-2915- U5	L	71	60	
11-2916- U6	XL	73	62	

			mm.	mm.
11-2931- L1	XXS	55	47	
11-2932- L2	XS	60	49	
11-2933- L3	S	72	54	
11-2934- L4	M	74	57	
11-2935- L5	L	76	59	
11-2936- L6	XL	78	61	

Partial impression trays for crown and bridge work.



11-2942- L2D
11-2944- L4D
11-2946- L6D

11-2952- L2S
11-2954- L4S
11-2956- L6S

**Stainless steel "Perforated"
impression trays without
retention rim.**

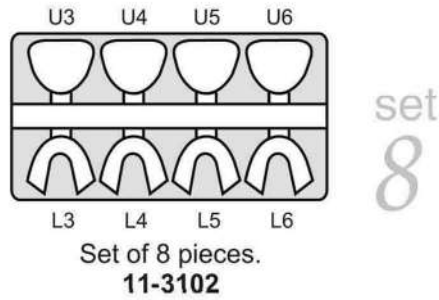

For Upper Jaw



		mm.	mm.
11-3111- U1	XXS	61	47
11-3112- U2	XS	64	51
11-3113- U3	S	66	53
11-3114- U4	M	69	57
11-3115- U5	L	71	60
11-3116- U6	XL	73	62

**Partial impression trays for crown
and bridge work.**



11-3142- L2D
11-3144- L4D
11-3146- L6D

**Stainless steel "Perforated"
impression trays without
retention rim.**

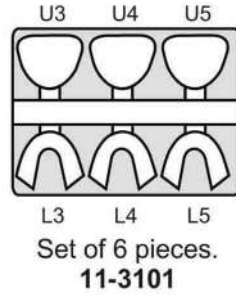

set
6

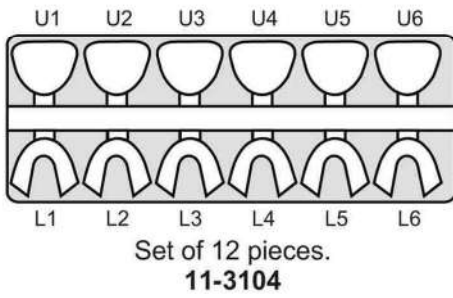
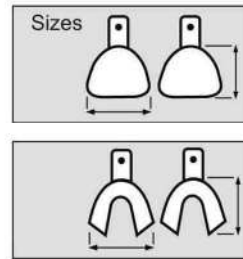

set
12



		mm.	mm.
11-3131- L1	XXS	55	47
11-3132- L2	XS	60	49
11-3133- L3	S	72	54
11-3134- L4	M	74	57
11-3135- L5	L	76	59
11-3136- L6	XL	78	61

11-3152-L2S
11-3154-L4S
11-3156-L6S



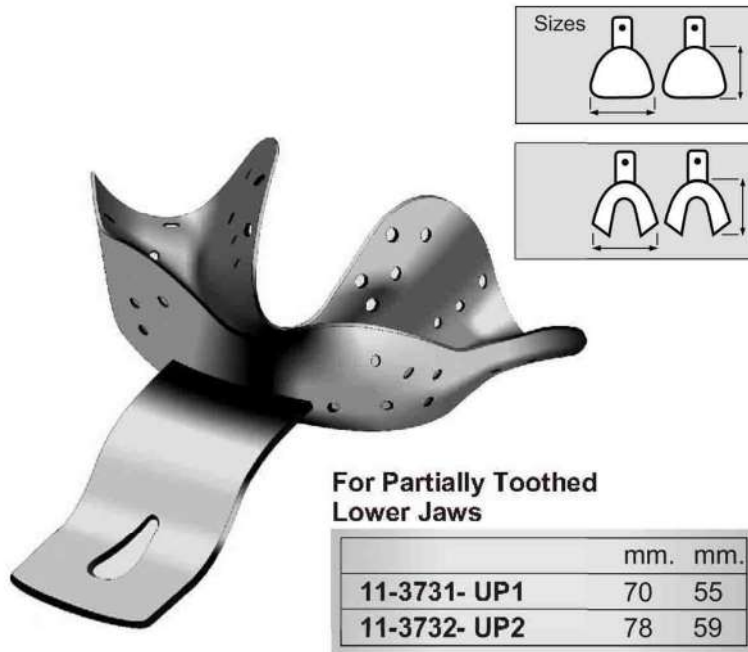

Sizes

For Partially Toothed Lower Jaws

	mm.	mm.
11-3731- UP1	70	55
11-3732- UP2	78	59

EHRICKE Stainless steel impression trays.

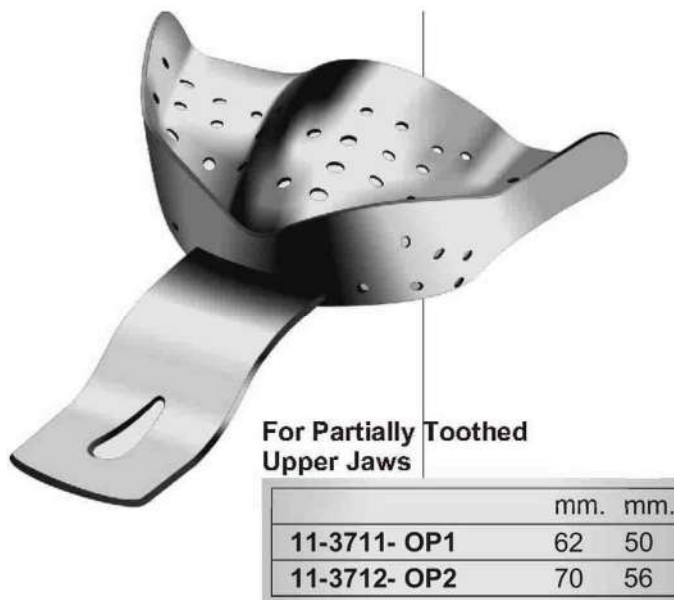

For Partially Toothed Upper Jaws

	mm.	mm.
11-3711- OP1	62	50
11-3712- OP2	70	56



For Edentulous
Upper Jaw

	mm.	mm.
11-3811- OU1	64	46
11-3814- OU2	68	53
11-3817- OU3	79	61



For Edentulous
Lower Jaw

	mm.	mm.
11-3831- UU1	70	48
11-3834- UU2	70	53
11-3837- UU3	72	57

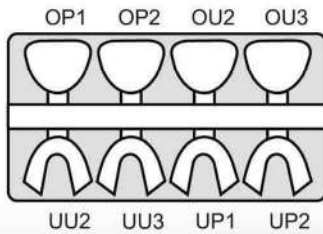

set
8

Set of 8 pieces.
11-3702

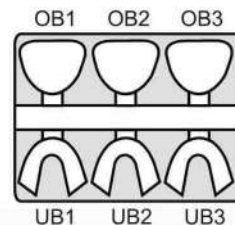

set
6

Set of 6 pieces.
11-3801



Pliers For Orthodontics
Zangen für Kieferorthopädie
Pinzas para orthodoncia
Pinces pour orthodontie
Pinze ortodontiche

Tel# 0092-52-4260785
Fax# 0092-52-4266804
Email. Info@benison.com.pk

Flat Nose Pliers

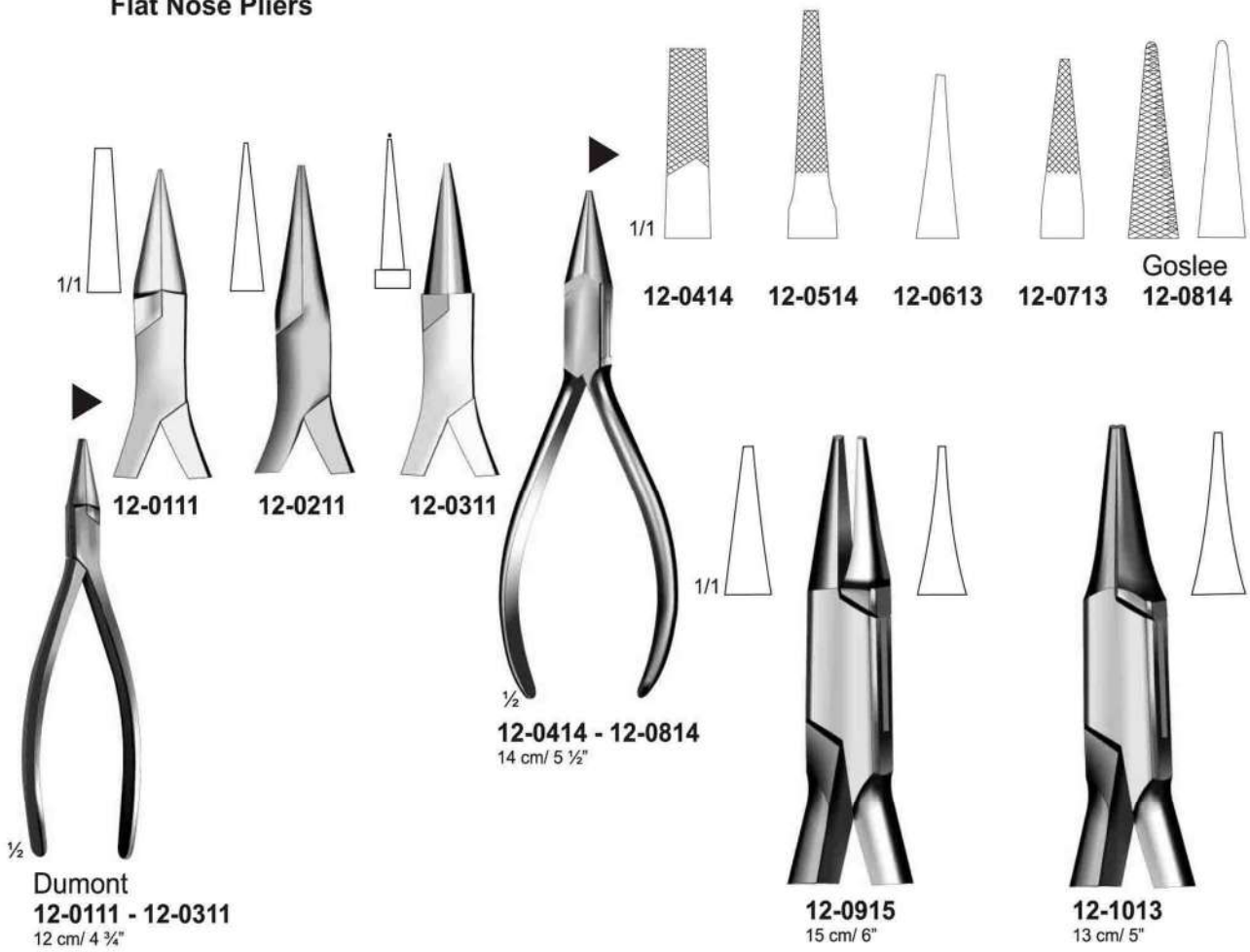

Bending Pliers



End and Side Nippers



Wire, Arch and clasp bending pliers

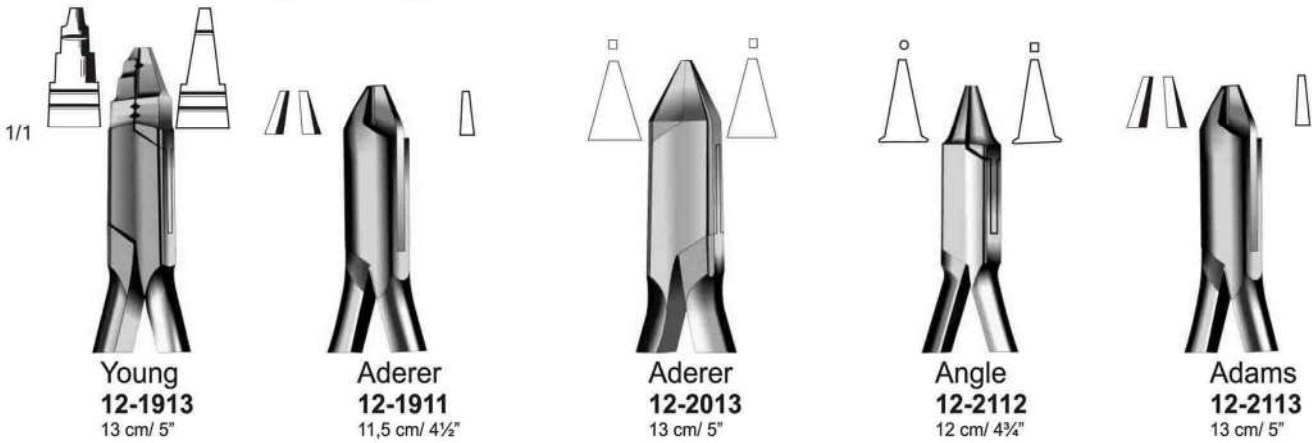

Crown Pliers, Contouring Pliers

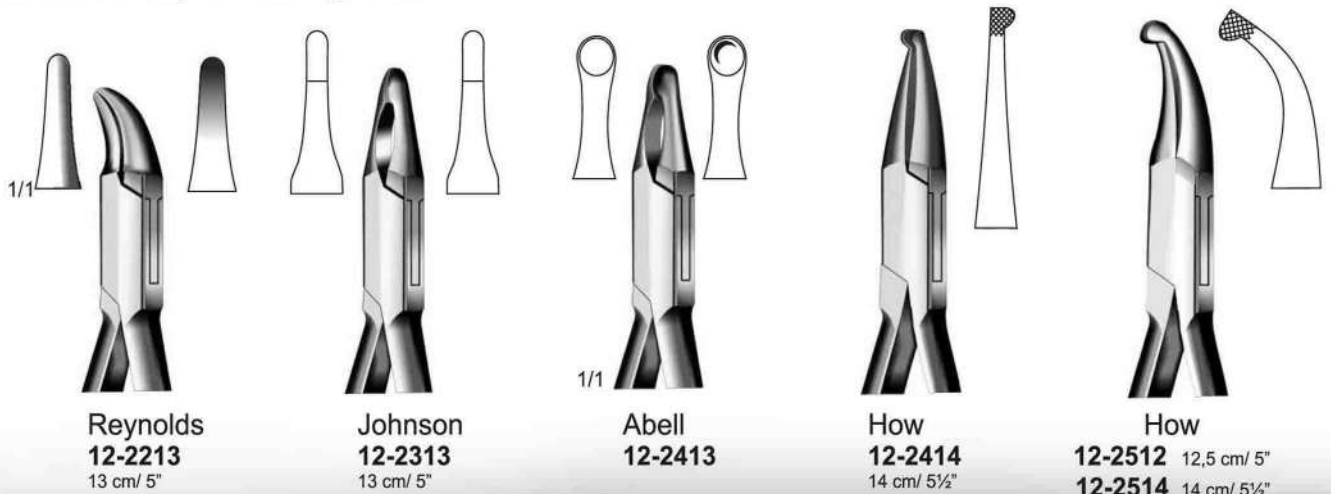

Universal Pliers, Copper Ring and
Bridge Removing Pliers



Waldsachs-Universal
12-2615
15,5 cm/ 5"



Universal
12-2715
15,5 cm/ 5"

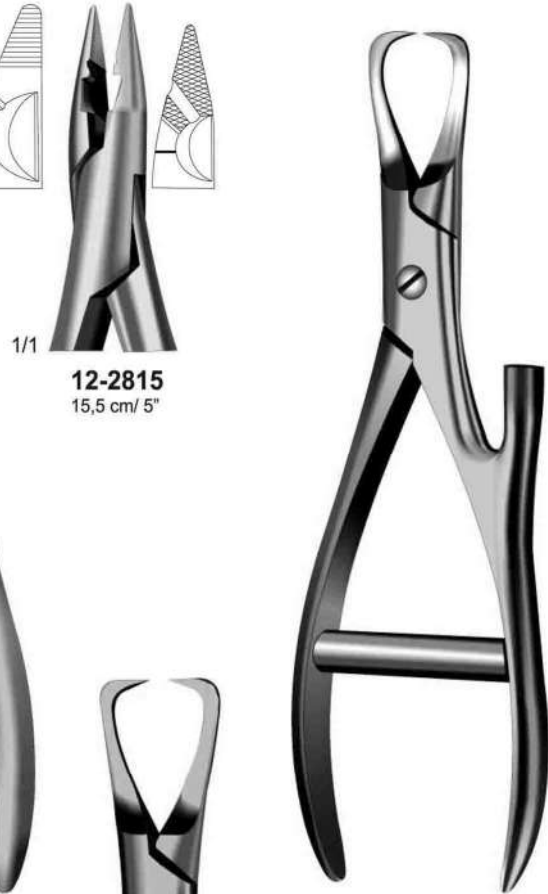

Lodo
12-3015
15 cm/ 5"



Furrer
12-2915
15,5 cm/ 5"

BAND SEATING & ARCH BENDING PLIERS



12-3013
13 cm/ 5¼"



Lingual Arch Plier
12-3112
11.5 cm/ 4¼"
Designed to form double and triple bends in either .030" (0.76 mm) or .036" (0.91 mm) wire for inserting lingual sheaths



12-3212
12 cm/ 4¾"

Remover



12-3213
13 cm/ 5"

Remover



De La Rosa
12-3312
11.5 cm/ 4½"
Arch Forming & Contouring Plier
With three grooves, for wires .016" (0.41 mm), 0.81" (0.46 mm) and .022" (0.56 mm).



De La Rosa
12-3412
11.5 cm/ 4½"
Arch Forming Plier, without grooves
Same Plier but without grooves



D.B. Bracket Removing Plier
12-3512 T/C
12 cm/ 4¾"
Useful for ceramic and stainless steel brackets. The tips wedge between edge of bracket and tooth surface and remove it with ease.

Remover



12-3612 T/C
12 cm/ 4¾"

Remover

Bond Bracket



12-3712 T/C
12 cm/ 4¾"



12-3812 T/C
12 cm/ 4¾"



12-3912 T/C
12 cm/ 4¾"



D.B. Bracket Removing Plier, with Pad
12-4012 T/C
12 cm/ 4¾"
Designed for quick and comfortable removal of direct bond brackets. It will also remove adhesive from the tooth.



Posterior Band Removing Plier, Long
12-4112 T/C
12 cm/ 4¾"
Will remove band with maximum patient comfort. The tip is postured in the middle of the pad for band removal ease. A plastic padded tip and a sharp removing beak allow, with a slight pressure, easy band removal.

Wire Bending Pliers

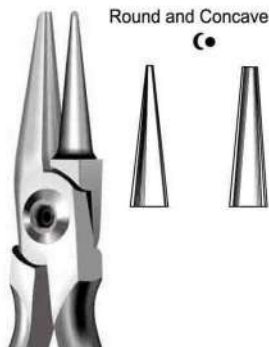

12-4212
12 cm/ 4¾"
Medium Wire Plier,
Round & Concave Plier
For wires up to .28" (0.71 mm)

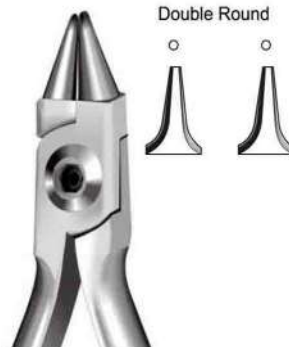

12-4312
11.5 cm/ 4½"
Double Rounded Jaw Plier
For wires up to .030".

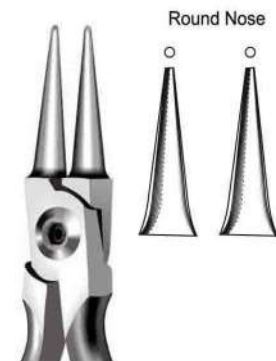

12-4412
12 cm/ 4¾"

Wire Bending Pliers

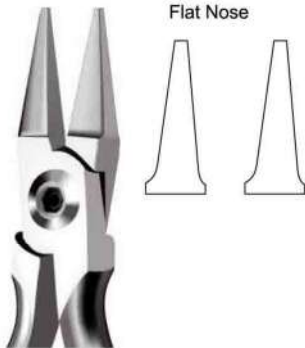

Jarabak
12-4413
 12.5 cm/ 5"
 Excellent for precise bending of light wires. Precision grooves assure accurate bending and closing loops. Wires up to .020".



Reynolds
12-4512
 12 cm/ 4¾"

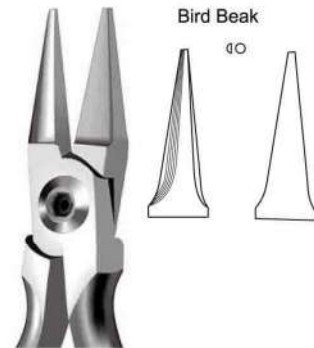

Light Wire Plier
12-4513
 12.5 cm/ 5"
 The beaks are more tapered and longer than Angle Plier. Excellent for bending small diameter loops. Used for wires up to .016" (0.41 mm)

Wire Arch Bending & Forming Pliers



Tweed
12-4611 T/C
 11.5 cm/ 4½"
 Rectangular Arch Pliers, Tweed Style Forming plier for square or rectangular wires. The blades are designed to be parallel at .020" (0.51 mm) opening. The working edges are carefully diamond-honed to prevent wire scoring.



Tweed(Angle)
12-4612 T/C
 12 cm/ 4¾"



Tweed(Angle)
12-4711 T/C
 11 cm/ 4½"



12-4811 T/C
 11 cm/ 4½"

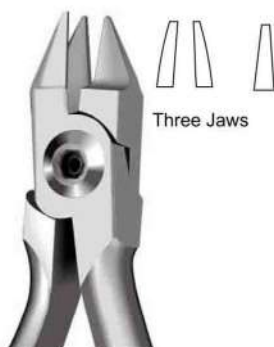

Aderer
12-4812
 11.5 cm/ 4½"
 Three Jaw Thin Plier, For wires up to .028" (0.71 mm).

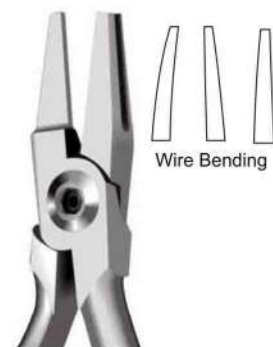

Aderer
12-4912
 12 cm/ 4¾".
 Three Jaw Plier, Aderer The precision aligned tips ensure for consistent bends. Gradually tapered for delicate bending. For wires up to 0.036" (0.91 mm)

Wire Arch Bending & Forming Pliers



How
12-4913
 13 cm / 5 1/4"
 Utility Plier, How Long well tapered shape, With 3/32" (2.4mm) gripping pads which are serrated and shaped, so that their centre line coincides with the axis of rotation of the plier and holds the wire securely. Beaks are rounded to be completely lip safe.



How
12-5013
 12.5 cm / 4 3/4"
 Utility Plier, How Style With 1/8" (3.2 mm) gripping pads, which are serrated to hold wire securely. Beaks are completely lip safe.

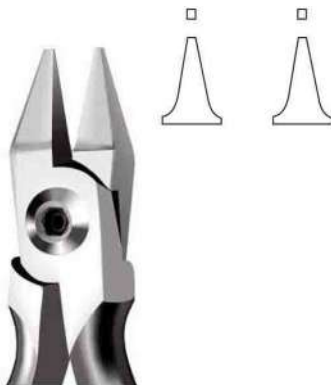

Weingart
12-5113 T/C
 12.5 cm / 4 3/4"
 Utility Plier, Weingart Classic design, generally utility plier. Pointed serrated tips. Holds wire firmly at convenient angle. The beaks are rounded to make the plier completely mouth safe. Useful for removal of ceramics

Loop Forming /Bending Pliers

Adams
12-5212
 12 cm / 4 3/4"

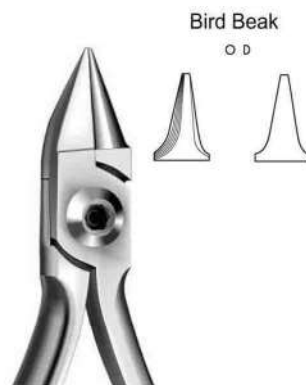

Angle
12-5312
 11.5 cm / 4 1/2"
 Bird Beaks Pliers, Angle It is used for working round wires up to .030" (0.76 mm) in diameter. The beaks are .025" (0.64 mm) at the tip. The beaks are parallel at 0.20" (0.51 mm) opening.

Loop Forming /Bending Pliers



Mckellops Plier
12-5313
12.5 cm/ 5¼"
For wires up to .059" (1.5 mm).



Tweed Loop
Forming



Tweed
12-5413

12.5 cm/ 5¼"
Loop Forming, Tweed Style Pliers Designed for making loops in round or rectangular wires up to 0.022x.0.28" (0.56 x 0.71 mm). The cylindrical beak has three sections: 0.045" (1.14mm), .060" (1.52mm), .075" (1.90mm). Each section is 0.090" in length. The concave beak has slight parallel serrations which orient and keep the wire at a right angle to the beaks while the loop is being formed.



Omega Loop
Forming



Tweed
12-5513

12.5 cm/ 5¼"
Omega Loop Forming Pliers, Tweed Style
It just differs from the Model 12-5413 in the concave beak which is rounded for making more uniform omega loops.



Single Diameter
Loop Forming



Tweed
12-5613

12.5 cm/ 5¼"



12-6612

Loop Closing Plier, Nance Style
Box joint with 4 sectioned tip for forming various size loops in rectangular and round wires.
For wires up to .028" (0.71 mm).

Wire Cutting Pliers



12-5713 T/C
12.5 cm/ 5"
Hard Wire Cutter, Flat Back
Cutting capacity up to .020 round,
Arch wire up to .022 x .028 and all
sizes of ligature wire and pins.



12-5813 T/C
12.5 cm/ 5"



12-5913 T/C
13 cm/ 5½"



12-6012 T/C
12 cm/ 5"



12-6112 T/C
11.5 cm/ 4½"



12-6212 T/C
12 cm/ 5"
Mini cut & hold distal end cutter
cuts within 0.5mm from end of
buccal tube. Use on wire up to
0.22" x 0.28" rectangular and
0.20" round.



12-6312 T/C
11.5 cm/ 4½"
Distal End Cutter with safety hold
It shear cuts hard wire and braided
wire and then, safely holds the loose
distal ends of the wire, thus preventing
from falling down into the oral tissues.
The cutting edges are diamond honed.
Maximum cutting capacity: rectangular
and twist wires up to .022 x .028"
(0.56 x 0.71); round wire up to .020"
(0.51 mm) in diameter.

Knives, Scalpels
Messer, Skalpelle
Bisturies
Bistouris
Bisturi

Scissors
Scheren
Tijeras
Ciseaux
Forbici

Forceps, Hemostatic Forceps
Pinzetten, Arterienklemmen
Pinzas, Pinzas hemostaticas
Pinces, Pinces hémostatiques
Pinzette, Pinze emostatiche

Needle holders
Nadel halter
Portaguja
Porte-aiguilles
Porta aghi

Retractors
Wundhaken
Separadores
Ecarteurs
Retrattori

Bone Cutting Forceps,
Bone Rongeurs
Hohlemeißelzangen,
Knochen Splitterzangen
Pinzas Cortentes para huesos
Pinces à os coupantes,
Pinces-gouges
Scalpellini e pinze alveolotome



Tel# 0092-52-4260785
Fax# 0092-52-4266804
Email. Info@benison.com.pk

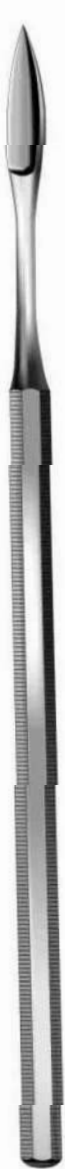

Ash
PE.25.01-
PE.25.03



1/1
PE.25.01
Fig. 1



PE.25.02
Fig.2



PE.25.03
Fig.3



1/1
PE.03.10
Fig.10



PE.03.11
Fig.11



Standard
PE.04.03
No.3



PE.09.04
No.4



PE.06.17
No.7K



PE.05.07
No.7



PE.10.40
No.3
straight



1/1
PE.03.12
Fig.12



PE.03.13
Fig.13



1/1
PE.03.14
Fig.14



PE.03.15
Fig.15



Standard
PC.14.14
PC.14.64 "TC"
PC.18.14.
PC.18.64 "TC"
14,5 cm/ 5 3/4"
Blunt/ Blunt



Standard
PC.15.14
PC.15.64 "TC"
PC.19.14
PC.19.64 "TC"
14,5 cm/ 5 3/4"
Sharp/ Sharp



Standard
PC.16.14
PC.16.64 "TC"
PC.17.14
PC.17.64 "TC"
14,5 cm/ 5 3/4"
Sharp/ Blunt



Metzenbaum
PC.36.14
14,5 cm/ 5 3/4"



Metzenbaum
PC.37.14
14,5 cm/ 5 3/4"



Metzenbaum-Delicate
PC.42.14 14,5 cm/ 5 3/4"
PC.44.18 18 cm/ 7"



Metzenbaum-Delicate
PC.43.14 14,5 cm/ 5 3/4"
PC.45.18 18 cm/ 7"



Gum Scissors
Zahnfleischscheren
Tijeras para encias
Ciseaux á gengives
Forbrci per gengiva



PC.01.11

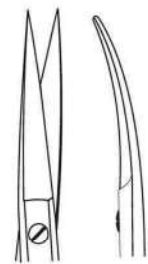

PC.02.11



PC.08.90



PC.08.91

PC.01.11-PC.08.91
11,5 cm/ 4 1/2"

Gum Scissors
Zahnfleischscheren
Tijeras para encias
Ciseaux á gengives
Forbrci per gengiva

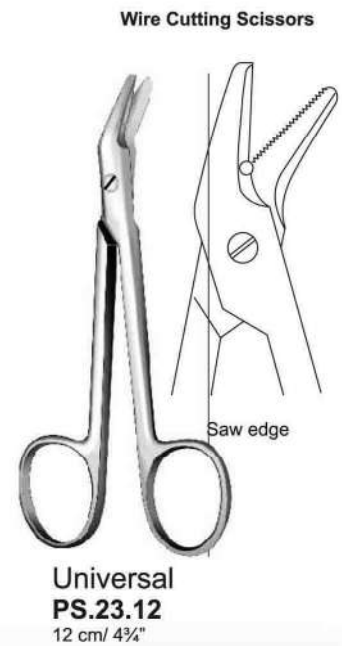
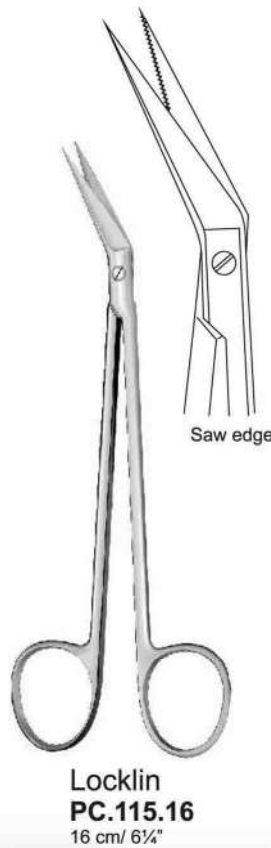
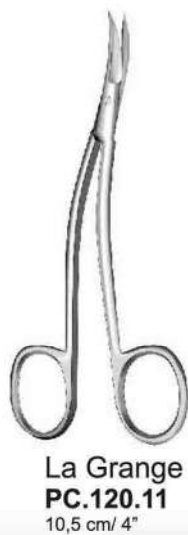
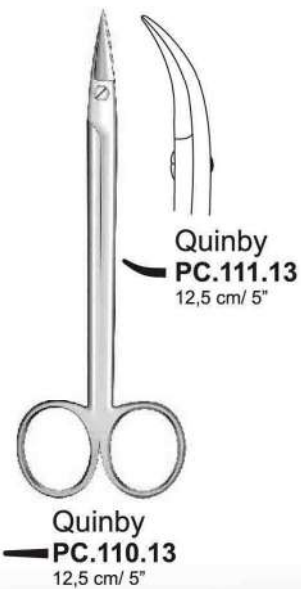
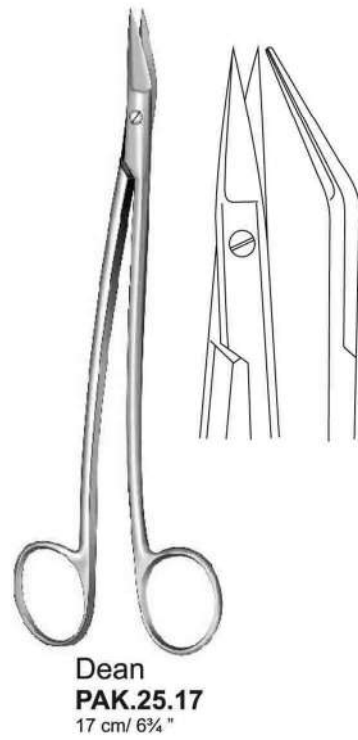
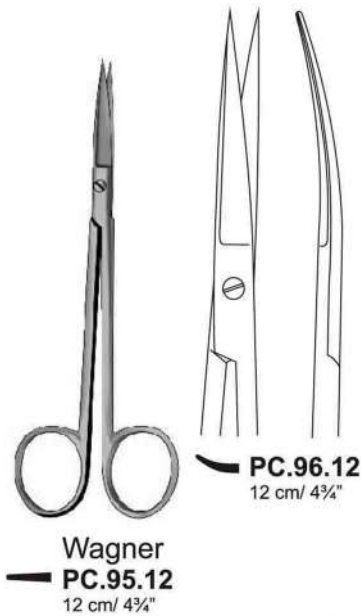
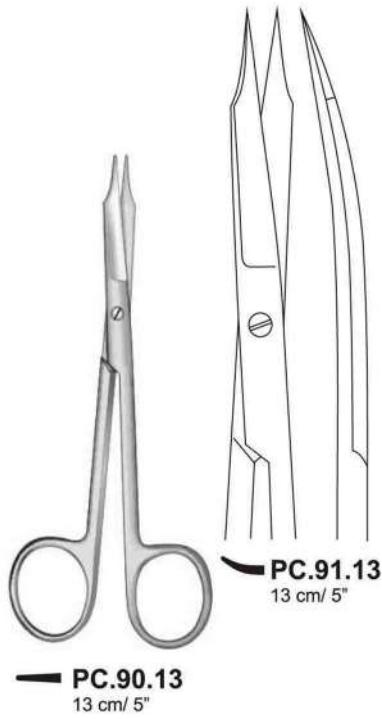



PC.91.53
13 cm/ 5"

Locklin
PC.115.66
16 cm/ 6 1/4"

Kelly
PC.46.66 16 cm/ 6 1/4"
PC.47.66 16 cm/ 6 1/4"

Metzenbaum
PC.36.64 14 cm/ 5 1/2"
PC.37.64 14 cm/ 5 1/2"
PC.38.70 20 cm/ 8"
PC.39.70 20 cm/ 8"

Metzenbaum-Fine
PC.42.64 14 cm/ 5 1/2"
PC.43.64 14 cm/ 5 1/2"
PC.44.70 20 cm/ 8"
PC.45.70 20 cm/ 8"

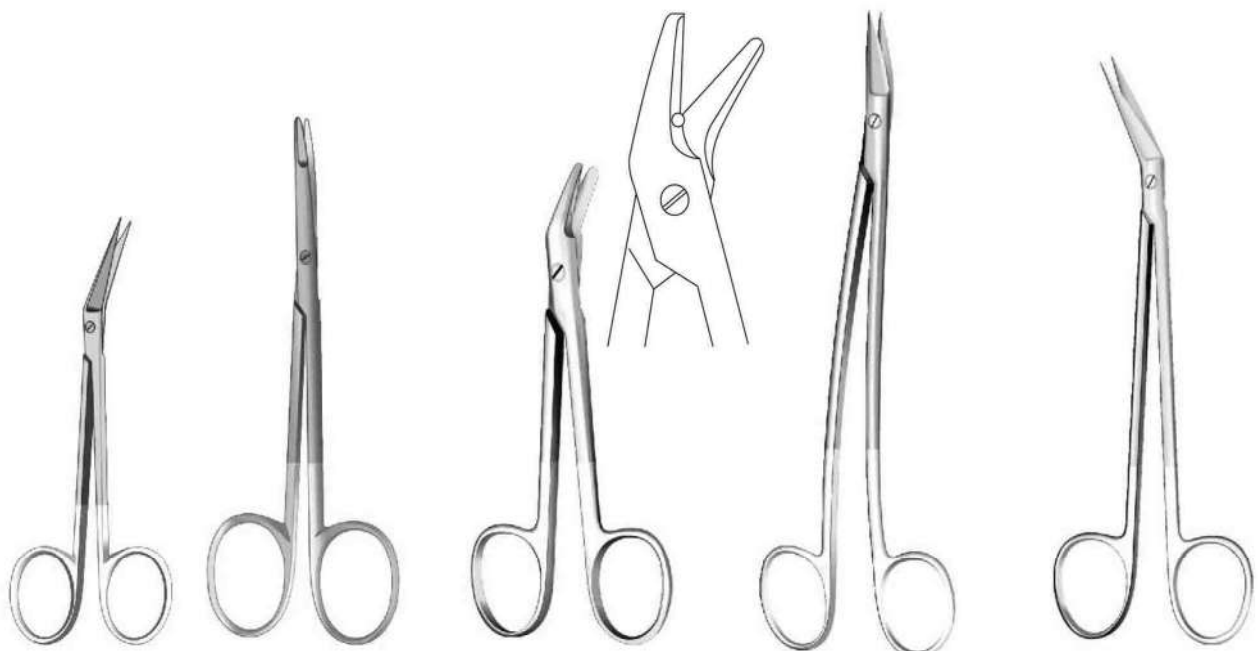

PC.08.92
11,5 cm/ 4 1/2"

Ragnell (Killner)
PC.59.63
13 cm/ 5 1/2"

Universal
PS.24.12
12 cm/ 4 3/4"

Dean
PAK.25.57
17 cm/ 6 3/4"

Locklin
PC.115.66
16 cm/ 6 1/4"
Saw Edge



12 cm/ 4¾"	Standard PF.01.11	Standard PF.05.11	Adson PF.15.12
14.5cm/ 5¾"	PF.01.14	PF.05.14	
15cm/ 6"	PF.01.15	PF.05.15	PF.15.15
16 cm/ 6¼"	PF.01.16	PF.05.16	
18 cm/ 7"	PF.01.18	PF.05.18	
20 cm/ 8"	PF.01.20	PF.05.20	
25 cm/ 10"	PF.01.25	PF.05.25	

Semken
PF.30.15
15.5 cm/ 6"

Adson
PF.16.12 12 cm/ 4¾"
PF.16.15 15 cm/ 6"

Adson Brown
PF.21.12
PF.21.15

With
Tungsten Carbide
"TC"



12 cm/ 4¾"	Standard "TC" PF.01.62	Narrow "TC" PF.03.62	Adson "TC" PF.15.62
14.5cm/ 5¾"	PF.01.64	PF.03.64	
15cm/ 6"	PF.01.65		PF.15.65
16 cm/ 6¼"	PF.01.66	PF.03.66	
18 cm/ 7"	PF.01.68	PF.03.68	

Cushing "TC"
PF.52.67
17cm / 6¾"

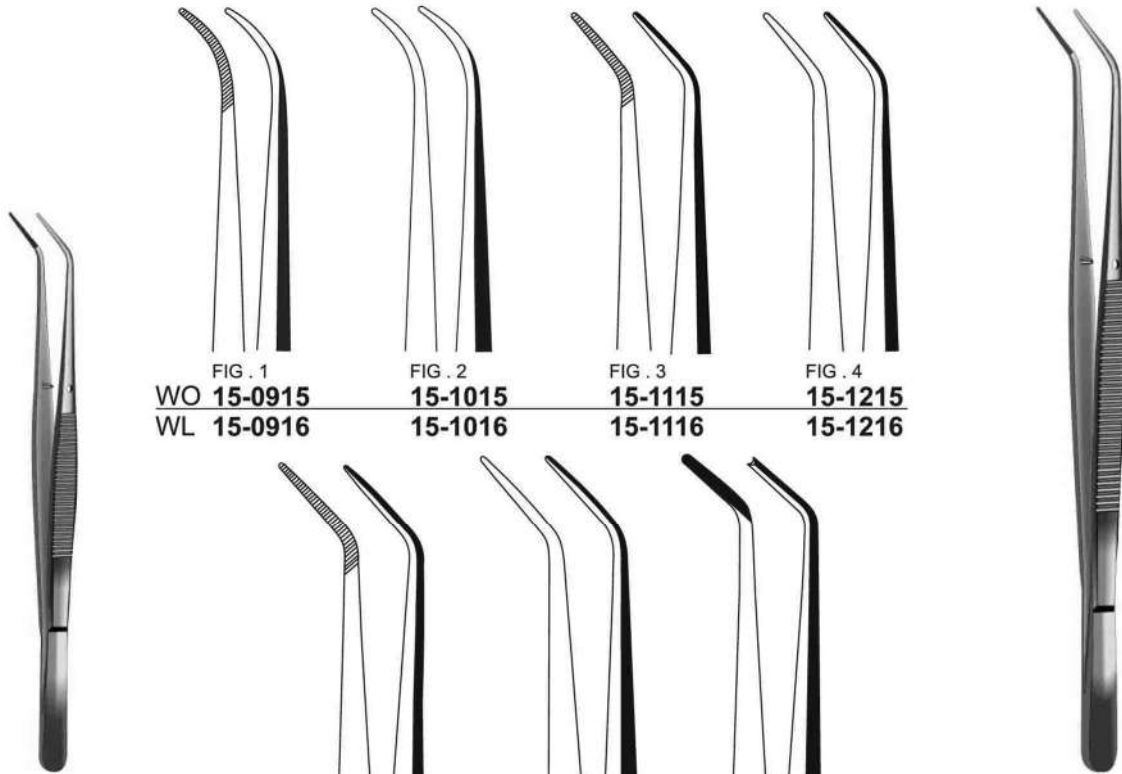

FIG . 1	FIG . 2	FIG . 3	FIG . 4
WO 15-0915	15-1015	15-1115	15-1215
WL 15-0916	15-1016	15-1116	15-1216

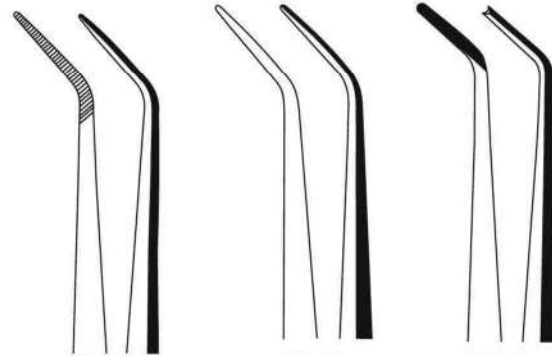

FIG . 5	FIG . 6	FIG . 7
WO 15-1315	15-1415	15-1515
WL 15-1316	15-1416	15-1516

London College
15 cm/ 6"
15-0915 - 15-1515
WO: Without Lock
15-0916 - 15-1516
WL: With Lock

Flagg
16 cm/ 6 1/4"
15-1616 Smooth
15-1626 Serrated

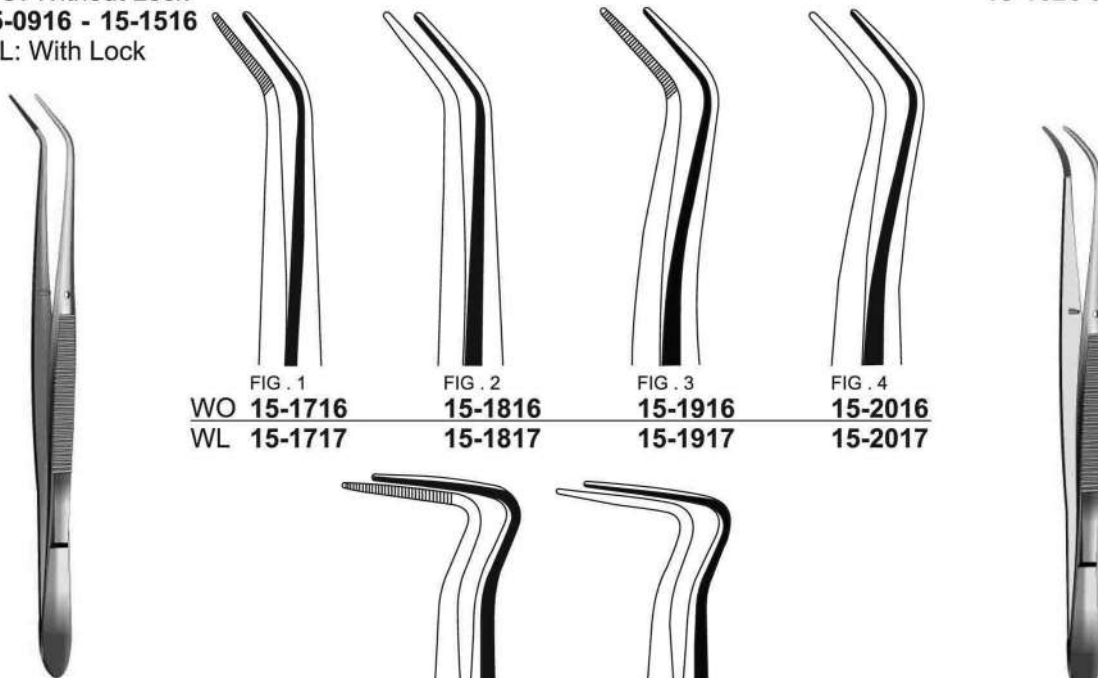

FIG . 1	FIG . 2	FIG . 3	FIG . 4
WO 15-1716	15-1816	15-1916	15-2016
WL 15-1717	15-1817	15-1917	15-2017

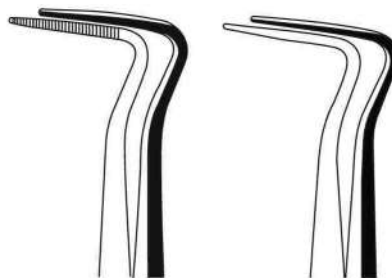

FIG . 5	FIG . 6
WO 15-2116	15-2216
WL 15-2117	15-2217

Meriam
16 cm/ 6 1/4"
15-1716 - 15-2216
WO: Without Lock
15-1717 - 15-2217
WL: With Lock

Perry
13 cm/ 5"
15-2410 Serrated
15-2413 Smooth



USA-Mod.
15-2615
15 cm/ 6"

15-2715
15 cm/ 6"

Caulk
15-2815
16,5cm/ 6½"

15-2915
15 cm/ 6"

Articulating Forceps

Albrecht
15-2516 Sharp
15-2517 Blunt
16 cm/ 6¼"



USA-Mod.
15-3016
16 cm/ 6¼"



USA-Mod.
15-3116
16 cm/ 6¼"



USA-Mod.
15-3216
16 cm/ 6¼"



Crane-Keplan
15-3301
14 cm/ 5½"



Crane-Keplan
15-3302
14 cm/ 5½"

Miller
15-3415
15cm/ 6 "



Jones
PI.19.06 6 cm/ 2 1/2"
PI.20.09 9 cm/ 3 1/2"



Backhaus
PI.25.08 8 cm/ 3 1/4"
PI.25.10 11 cm/ 4 1/2"
PI.26.13 13 cm/ 5"

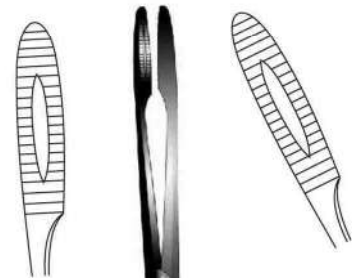

PG.11.20
PG.13.26

PG.12.20
PG.14.26

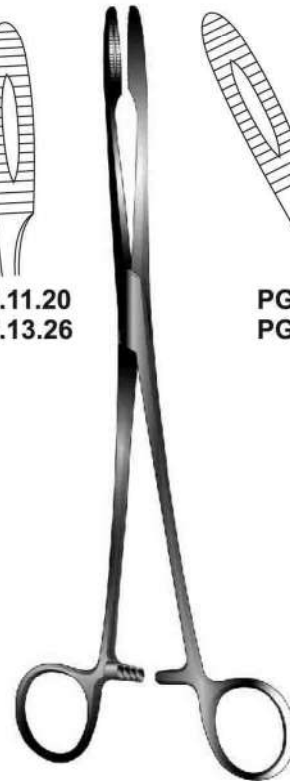

Gross-Maier
PG.11.20 - PG.13.26
PG.12.20 - PG.14.26
20cm/ 8" 26cm/ 10 1/4"



1/1
PH.40.09

PH.41.09

Hartmann
PH.40.09 - PH.41.09
10 cm/4" Straight 10 cm/4" Curved

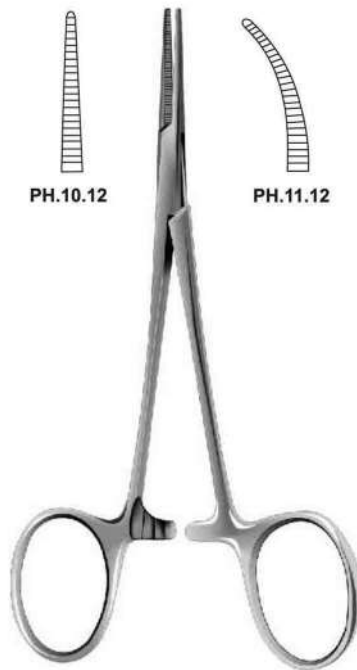

PH.10.12

PH.11.12

Halstead
PH.10.12 - PH.11.12
12 cm/4 3/4" Straight 12 cm/4 3/4" Curved

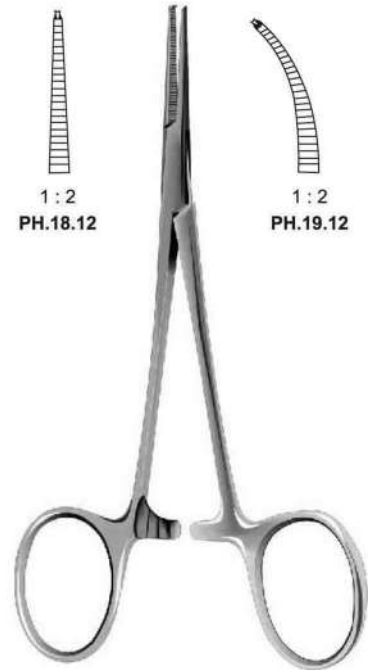

1 : 2
PH.18.12

1 : 2
PH.19.12

Halsted-Mosquito
PH.18.12 - PH.19.12
12,5 cm/5" Straight 12 cm/5" Curved

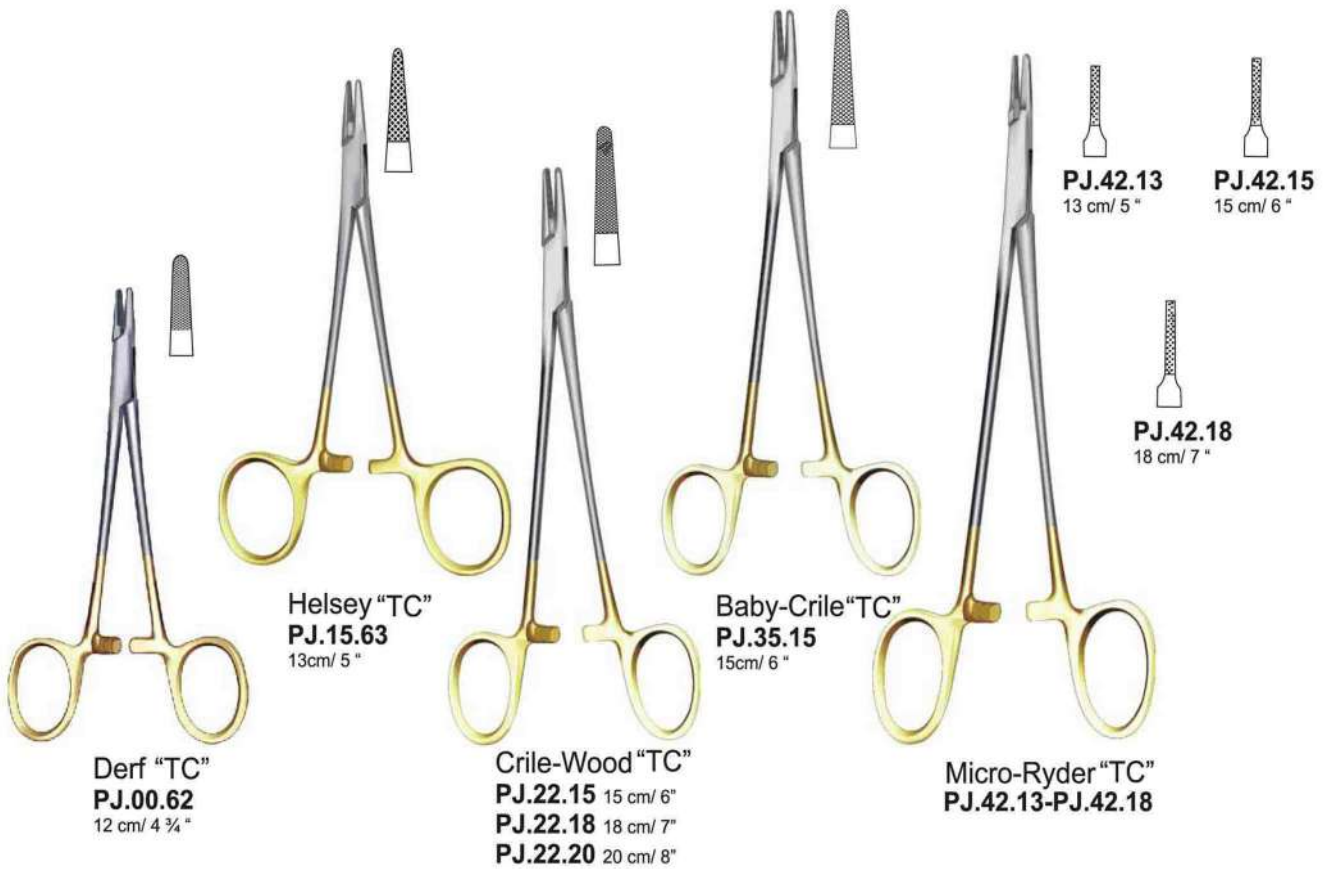





Frazier
PY.11.12-
PY.11.13
13 cm/ 5 ¼"

Kilner
PAE.11.15
15 cm/ 6 "

Guthrie
PY.25.13
13 cm/ 5"

Gillies
PY.12.19-
PY.12.20
19 cm/ 7"

Senn-Miller
PY.01.16
16 cm/ 6¼"

PY.31.01 -
PY.31.04
16 cm/ 6¼"

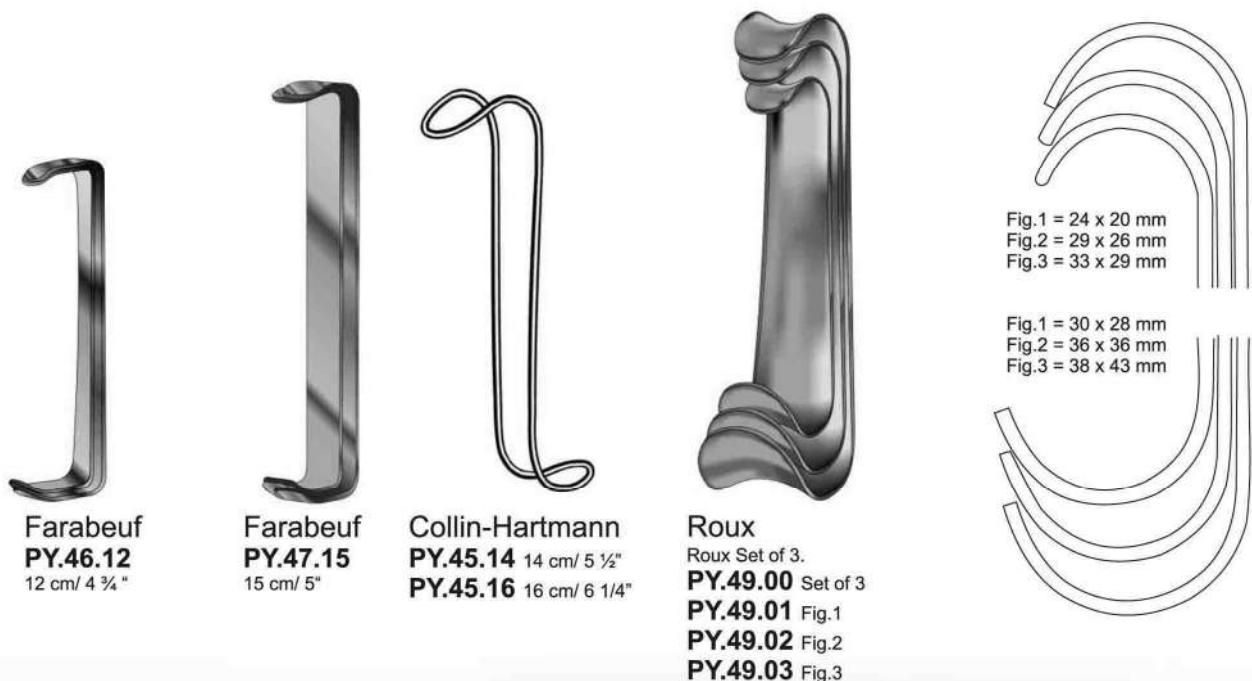

Farabeuf
PY.46.12
12 cm/ 4 ¾"

Farabeuf
PY.47.15
15 cm/ 5"

Collin-Hartmann
PY.45.14 14 cm/ 5 ½"
PY.45.16 16 cm/ 6 ¼"

Roux
Roux Set of 3.
PY.49.00 Set of 3
PY.49.01 Fig.1
PY.49.02 Fig.2
PY.49.03 Fig.3

Fig.1 = 24 x 20 mm
Fig.2 = 29 x 26 mm
Fig.3 = 33 x 29 mm

Fig.1 = 30 x 28 mm
Fig.2 = 36 x 36 mm
Fig.3 = 38 x 43 mm

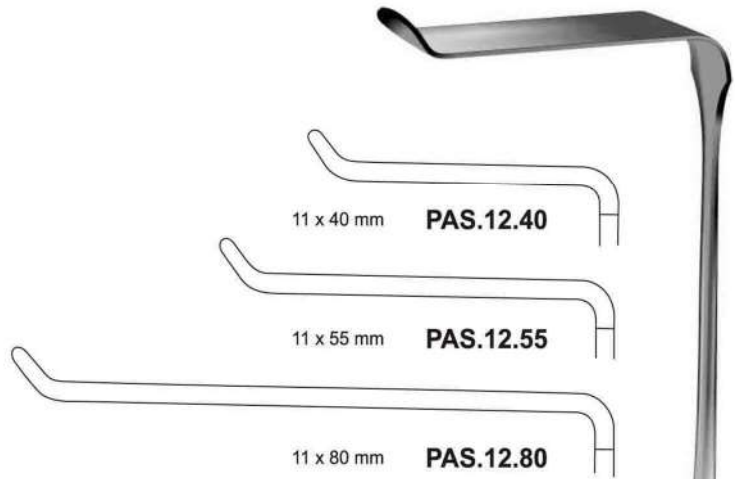
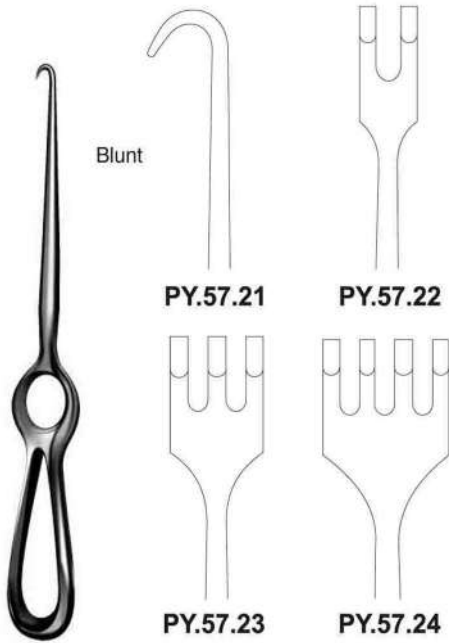

Volkmann
PY.57.21-PY.57.24
21.5 cm/ 8 1/2"

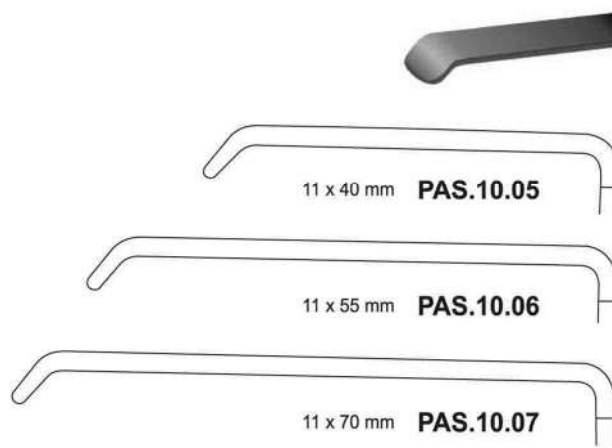

Obwegeser
PAS.12.40-
PAS.12.80
22 cm/8 3/4"

Langenbeck
PY.71.01- PY.71.03
21cm/ 8 1/4"

Obwegeser
PAS.10.05 -
PAS.10.07
21,5 cm/8 1/2"



Williger
PT.11.17
17 cm/6 3/4"



Williger
PT.12.04
16 cm/6 1/4"



Freer
PAM.28.21
21.5 cm/ 8 1/2"



PT.19.20
17,5 cm/7"



Molt
PT.19.21
19 cm/7 1/2"

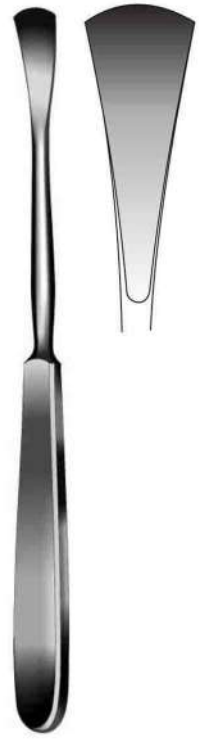

Lengenbeck
PT.37.35
19 cm/7 1/2"

Bone Nibblers.

- 1mm
PAC.37.01
- 2mm
PAC.37.02
- 3mm
PAC.37.03



Citelli
PAC.37.01-
PAC.37.03
17 cm/6 3/4"

- 4 x 4 mm
PAC.36.01
- 5 x 5 mm
PAC.36.02
- 6 x 6 mm
PAC.36.03



Kerrison
PAC.36.01-
PAC.36.03



Friedman
PX.01.14
14 cm/5 1/2"

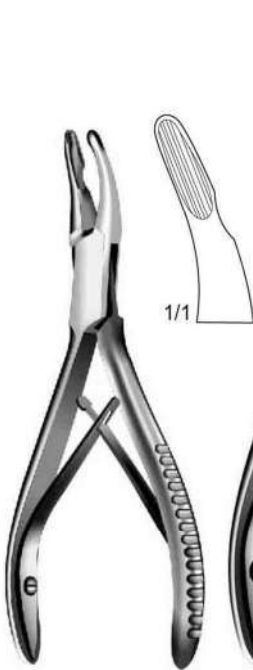

Cleveland
PX.04.14
14 cm/5 1/2"



Cleveland 4A
PX.04.17
17 cm/6 3/4"



Luer
PX.20.65
15 cm/6"



Luer
PX.20.75
15 cm/6"

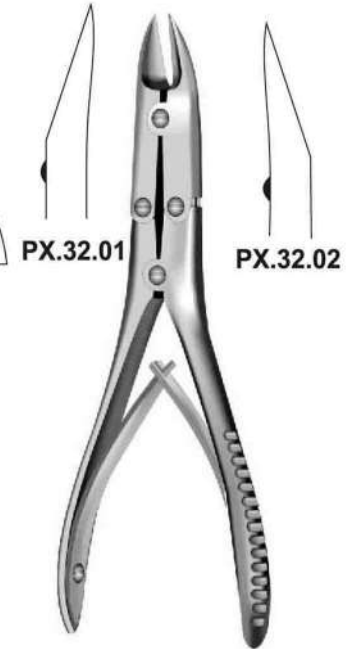

Bohler
PX.32.01-PX.32.02
15 cm/6"

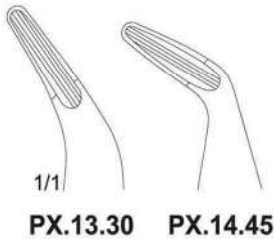

PX.13.30 PX.14.45



PX.15.90

Blumenthal
PX.13.30-
PX.15.90
16 cm/6"



Beyer
PX.31.16
15,5 cm/6"



Beyer
PX.31.18
18 cm/7"



Cleveland 5 S
PU.04.14
14cm/5 1/2"



Cleveland 5
PU.05.17
17 cm/6 3/4"

Dermal Punch, Probes Gauze Packer
 Lip Retractor Tongue Depressor
 Hauttrephines Knopfsonden Tamponstopfer
 Lippenhalter, Zungenspatel
 Trepanos Cutaneos estiletos abotonados,
 Taponadores! Separadores de los labios bajaleguas
 Trepans cutanes sondes porte
 tampones ecarteurs des levres
 Aspiratori per soliva porta tamponi, Separatore
 del labbro, Spatola per Lingua

- 2 mm ○ PAE.10.62
- 3 mm ○ PAE.10.63
- 4 mm ○ PAE.10.64
- 5 mm ○ PAE.10.65
- 6 mm ○ PAE.10.66
- 7 mm ○ PAE.10.67
- 8 mm ○ PAE.10.68



Keyes
PAE.10.62-
PAE.10.68



Farrell Ø 0.9 mm
PB.16.12 12 cm/ 4 ¾"
PB.16.14 14 cm/ 5 ½"
PB.16.16 16 cm/ 6 ¼"



Bowmann
PAB.94.00
Set of 4
PAB.94.01 Fig 1+2
PAB.94.03 Fig 3+4
PAB.94.05 Fig 5+6
PAB.94.07 Fig 7+8



Ø 1.5 mm	Ø 2 mm	
PB.01.10	PB.02.10	11 cm/ 4 ¼"
PB.01.13	PB.02.13	13 cm/ 5"
PB.01.14	PB.02.14	14 cm/ 5 ½"
PB.01.16	PB.02.16	16 cm/ 6 ¼"



Luniatchek
PAK.30.19
 19 cm/7 ½"



Luniatchek
PAK.30.20
 19 cm/7 ½"



Sternberg
PAS.03.15
 14 cm/5 ½"



Sternberg
PAS.03.16
 16 cm/6 ¼"



Bruenings
PAS.05.18
 19 cm/7 ½"



PAS.03.16
 Wood
 16 cm/ 6 ¼"



Kroenig
PAS.03.14
 15 cm/6"



Mayo
PAS.04.17
 17 cm/6 ¼"

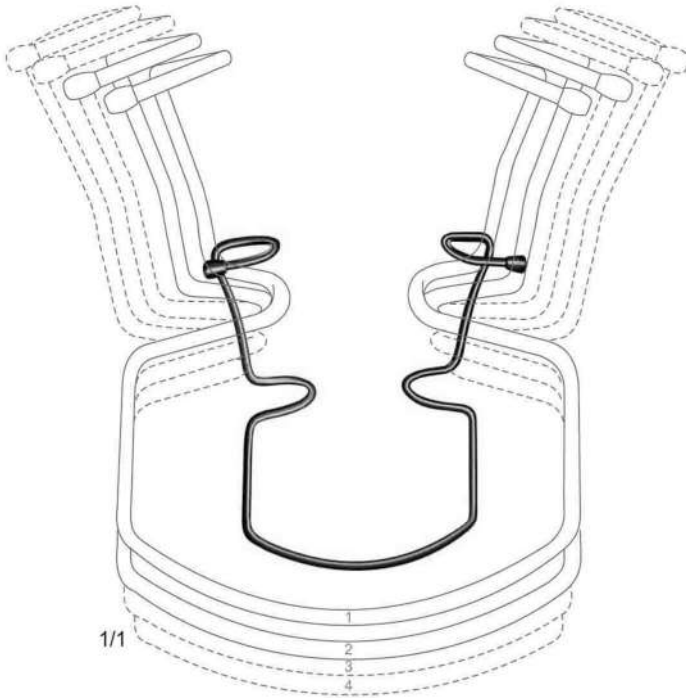

Oringer
PAQ.01.00 Fig.1
PAQ.01.02 Fig.2
PAQ.01.03 Fig.3
PAQ.01.04 Fig.4
PAQ.01.13 Set of 4

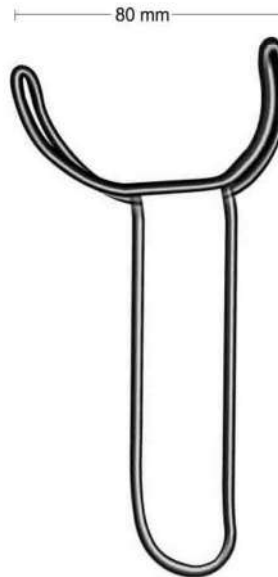

Vestibelum-Haken
PAQ.01.15
15cm/ 6"



Heister
PAQ.05.05
13 cm/ 5"

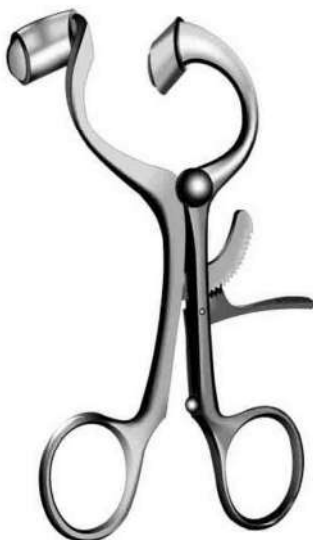

Molt
PAQ.07.15
15cm/6"



Jennings
PAQ.09.09 9 cm/ 3 1/2"
PAQ.09.11 11 cm/ 4 1/4"
PAQ.09.13 13 cm/ 5"
PAQ.09.15 15 cm/ 6"



Roser-Konig
PAQ.13.45 16 cm/6 1/4"
PAQ.13.50 20 cm/7 1/2"



Denhart
PAQ.14.60
13 cm/5"



Fig. 1
PV.37.11
Fig. 21
PV.37.12
Fig. 31
PV.37.14

Passow
PV.37.11-
PV.37.14
 12 cm/ 4 3/4"



Parsch
 13,5 cm/5 1/2"



Parsch
 13,5 cm/5 1/2"

	17 cm/6 3/4"	13,5 cm/5 1/2"	17 cm/6 3/4"	13,5 cm/5 1/2"
3 mm	PV.05.03	PV.05.53	PV.06.03	PV.06.53
4 mm	PV.05.04	PV.05.54	PV.06.04	PV.06.54
5 mm	PV.05.05	PV.05.55	PV.06.05	PV.06.55
6 mm	PV.05.06	PV.05.56	PV.06.06	PV.06.56



4 mm
PAN.28.04
7 mm
PAN.28.07
12 mm
PAN.28.12

Cottle
PAN.28.04-
PAN.28.12



Volkmann
PW.14.22-PW.14.56
 17 cm/6 3/4"

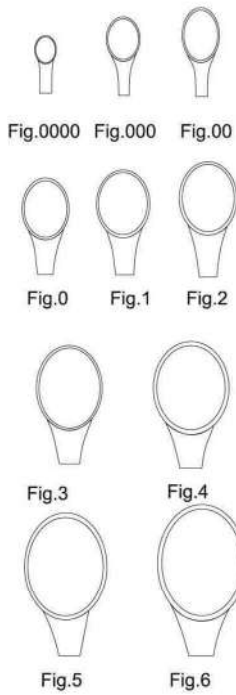

PW.14.24 Fig.0000
PW.14.33 Fig.000
PW.14.42 Fig.00
PW.14.50 Fig.0
PW.14.51 Fig.1
PW.14.52 Fig.2
PW.14.53 Fig.3
PW.14.54 Fig.4
PW.14.55 Fig.5
PW.14.56 Fig.6



Williger
PW.21.10-
PW.21.12
 13,5 cm/5 1/2"

PW.21.10
PW.21.11
PW.21.12



Parsch
PW.30.15
 15 cm/6"
 Fig.1



Parsch
PW.31.15
 15 cm/6"
 Fig.2

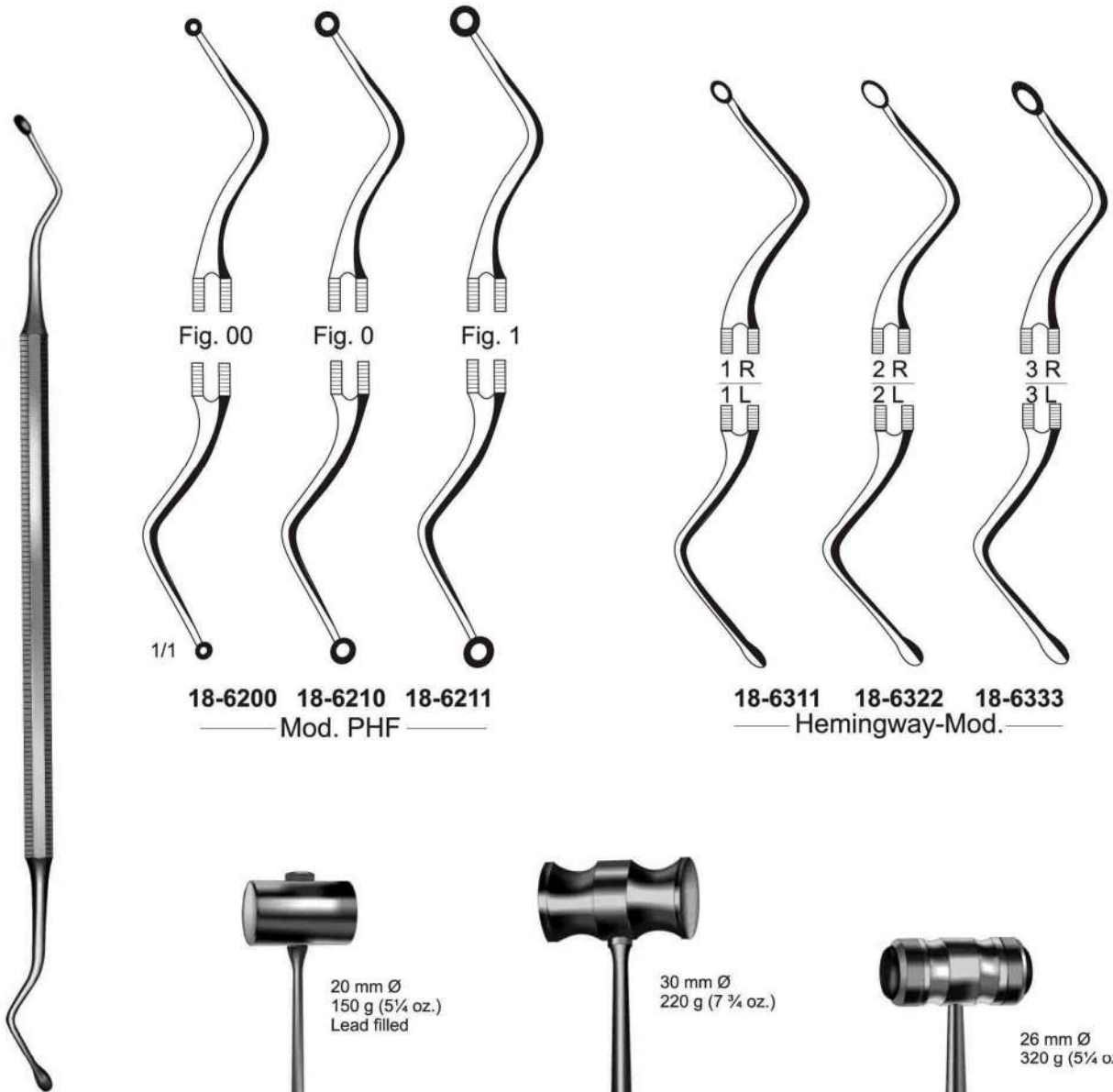

18-6200-18-6211
18-6311-18-6333

PM.01.16
16,5 cm/ 6½"

Collin
PM.05.20
20 cm/ 8"

Mead
PM.06.19
Massive - solid
17 cm/ 6¾"

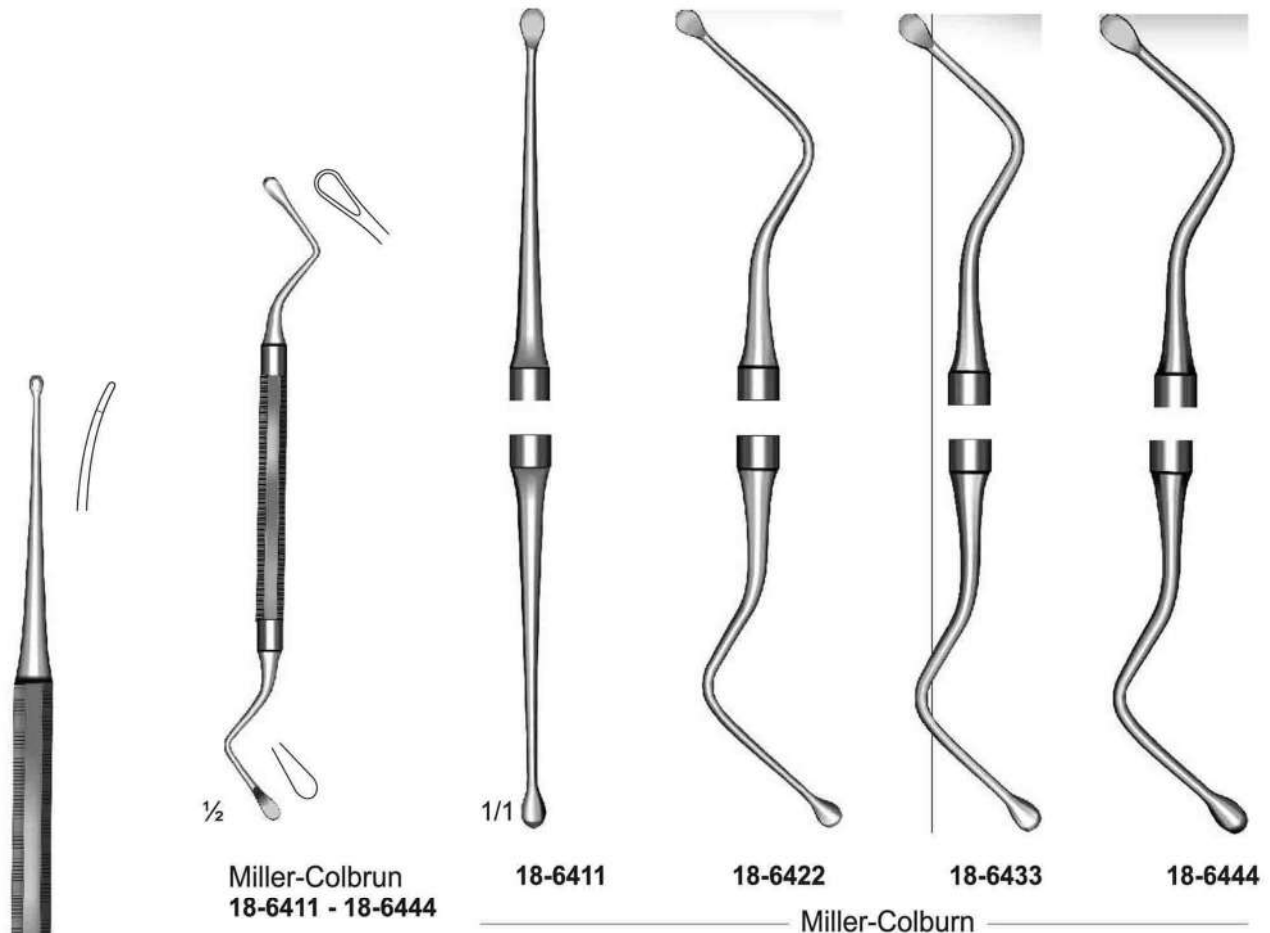

Miller-Colbrun
18-6411 - 18-6444

18-6411

18-6422

18-6433

18-6444

Miller-Colburn

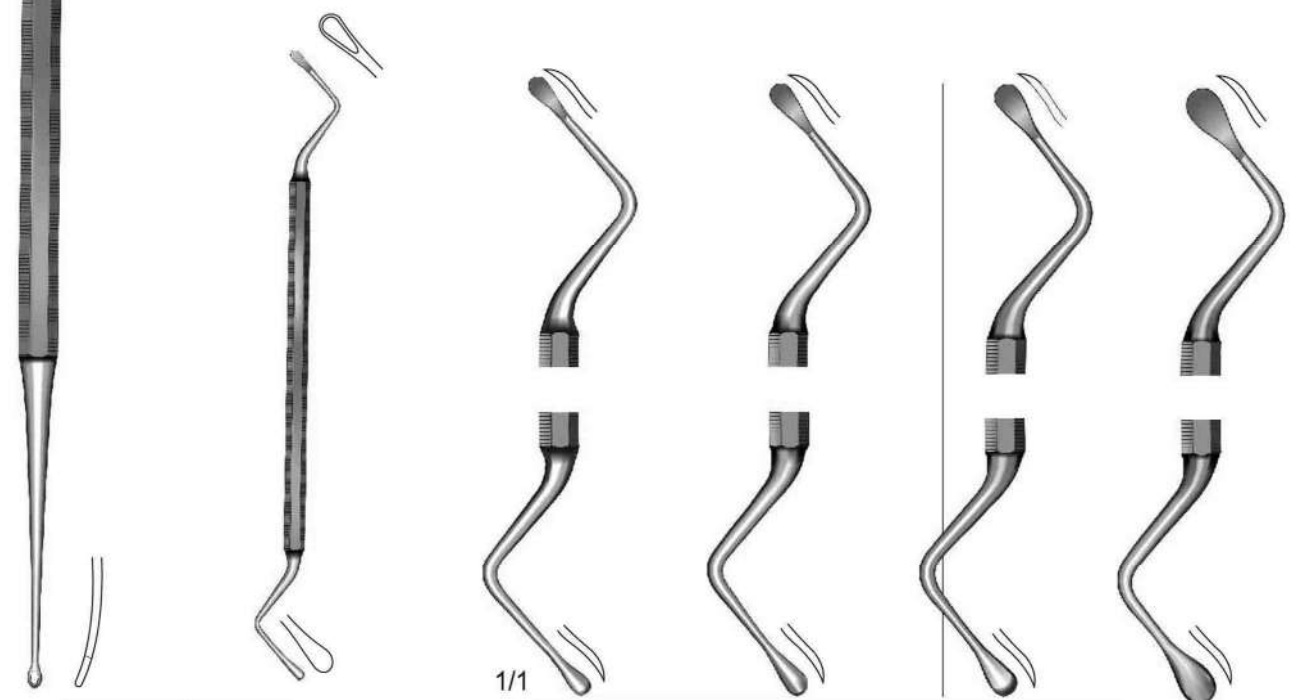

18-6401

Lucas
18-6501 - 18-6504

18-6501

18-6502

18-6503

18-6504

Lucas



Wieder
**PAS.02.21-
PAS.02.22**

Tobold PAS.01.14
14.5 cm/5 1/2"





Sterlization, Asepsis
Sterlization, Asepsis
Esterilization, Asepsia
Sterilisation, Asepsis
Sterilizzazione, Asepsi

Tel# 0092-52-4260785
Fax# 0092-52-4266804
Email. Info@benison.com.pk

Needle Cases



PR.15.05 = 50 x 25 x 4,5 mm
PR.15.08 = 65 x 42 x 8 mm
PR.15.06 = 75 x 25 x 4,5 mm



PR.16.05 = 50 x 25 x 4,5 mm
PR.16.08 = 65 x 42 x 8 mm
PR.16.06 = 75 x 25 x 4,5 mm



Trays



PAF.05.63
 235 x 190 x 40 mm

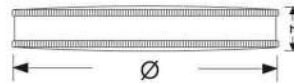

complete	insert only
PR.19.65	PR.19.70
Ø = 65 mm	Ø = 62 mm
h = 15 mm	h = 13 mm



PAF.05.82
 Ø 200 x 70 mm



	l	b	h
PAF.04.20	200	150	38
PAF.04.25	250	200	50
PAF.04.30	300	250	50
PAF.04.35	355	305	50
PAF.04.40	405	305	50

PAF.04.20- PAF.04.40

Forceps Jars



Size in mm Ø X h	Jar without lid	Jar with lid
30 x 90	PAF.15.30	PAF.15.54
50 x 100	PAF.15.50	PAF.15.55
50 x 130	PAF.15.51	PAF.15.56
50 x 175	PAF.15.52	PAF.15.57
75 x 100	PAF.15.75	PAF.15.80
75 x 130	PAF.15.76	PAF.15.81
75 x 175	PAF.15.77	PAF.15.82
100 x 175	PAF.15.98	PAF.15.88
100 x 200	PAF.15.99	PAF.15.89

Instrument Box



PAF.20.20
205 x 105 x 40 mm

Kidney Trays



Size in mm l x b x h		
170 x 100 x 35	PAF.10.17	17 cm/ 6 ¾"
250 x 140 x 40	PAF.10.25	25 cm/ 10"
275 x 150 x 45	PAF.10.27	27 cm/ 10 ¾"

Instrument Boxes



Size in mm

L x w x h

165 x 85 x 35	PAF.21.46
200 x 100 x 35	PAF.21.50
200 x 100 x 50	PAF.21.51
230 x 130 x 50	PAF.21.53
260 x 150 x 50	PAF.21.56

270 x 235 x 50	PAF.21.57
300 x 200 x 50	PAF.21.60
325 x 275 x 30	PAF.21.62
325 x 275 x 50	PAF.21.63
420 x 80 x 40	PAF.21.72

420 x 175 x 50	PAF.21.75
----------------	------------------

Cotton Dispensers



Methot
PAF.35.01 **PAF.35.02**
 With lid Without lid
 ø50 x 75 mm



Spirit Lamp
19-1505
 120 cc

Cotton wool containers



Size in mm Lid with knob
 ø X h

75 x 60	PAF.08.07
75 x 75	PAF.08.08
100 x 60	PAF.08.10
100 x 100	PAF.08.11
125 x 80	PAF.08.12
125 x 125	PAF.08.13
150 x 100	PAF.08.14
150 x 150	PAF.08.15
200 x 100	PAF.08.20
200 x 150	PAF.08.21
200 x 200	PAF.08.22
240 x 160	PAF.08.24
240 x 230	PAF.08.25
290 x 160	PAF.08.29
290 x 240	PAF.08.30

Sterilization Drums



Schimmelbusch
 (Horizontal Ventilation)

Ø	h	
140 x 140 mm		PR.25.14
160 x 150 mm		PR.25.16
190 x 160 mm		PR.25.19
190 x 190 mm		PR.25.20
240 x 120 mm		PR.25.24
240 x 160 mm		PR.25.25
240 x 240 mm		PR.25.27
290 x 160 mm		PR.25.29
290 x 240 mm		PR.25.30
340 x 160 mm		PR.25.34
340 x 240 mm		PR.25.35
390 x 140 mm		PR.25.39
390 x 190 mm		PR.25.40
390 x 290 mm		PR.25.41



Konrich
 (Vertical Ventilation)

Ø	h	
140 x 140 mm		PR.26.14
160 x 150 mm		PR.26.16
190 x 160 mm		PR.26.19
190 x 190 mm		PR.26.20
240 x 120 mm		PR.26.24
240 x 160 mm		PR.26.25
240 x 240 mm		PR.26.27
290 x 160 mm		PR.26.29
290 x 240 mm		PR.26.30
340 x 160 mm		PR.26.34
340 x 240 mm		PR.26.35
390 x 140 mm		PR.26.39
390 x 190 mm		PR.26.40
390 x 290 mm		PR.26.41

Norm Trays



19-2101 - 19-2104
 288 x 187 x 40 mm

19-2201 - 19-2204
 288 x 93 x 40 mm

	Tablet	Lid	
19-2101	Perforated	Unperforated	19-2201
19-2102	Unperforated	Unperforated	19-2202
19-2103	Perforated	Perforated	19-2203
19-2104	Unperforated	Perforated	19-2204

Inserts for Trays

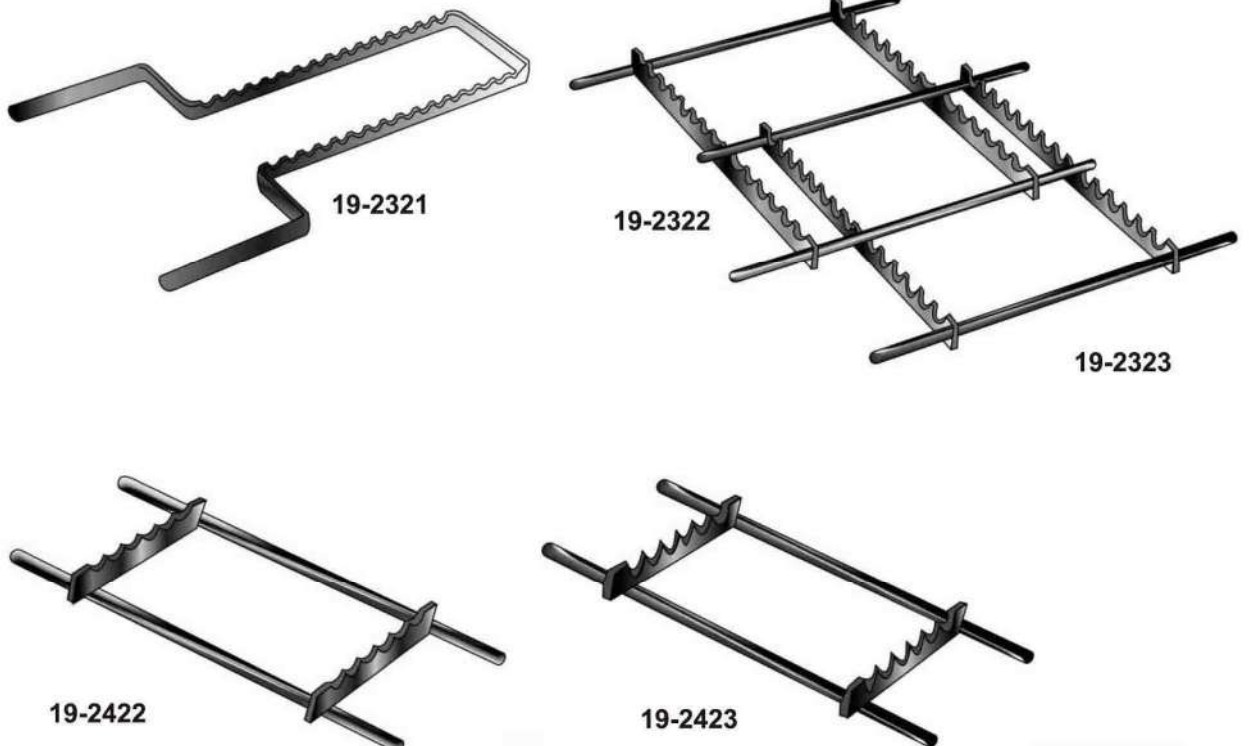



Surgery
Chirurgie
Chirguia
Chirurgie
Chirurgia

Tel# 0092-52-4260785
Fax# 0092-52-4266804
Email. Info@benison.com.pk

With additional side holes

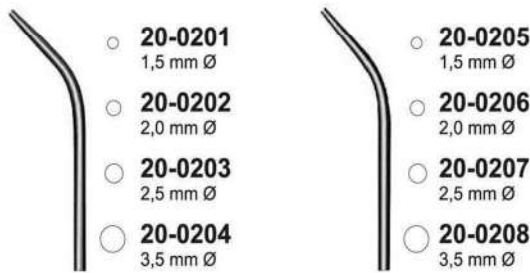

6 mm
round

6 mm
oval

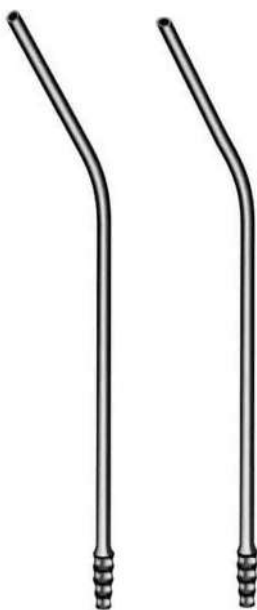

Nuboer
20-0121
21 cm/8½"

Nuboer
20-0122
21 cm/8½"



Coupland
20-0217
17 cm/ 6 ¾"



Byrd
20-0301-
20-0303
20 cm/ 8"



Cogswell
20-0423
23 cm/ 9"



Adson
PB.39.32
4 mm
21 cm/ 8 ½"



Frazier
Charr. / Fr.
PB.36.86 6
PB.36.88 8
PB.36.90 10
PB.36.92 12
19 cm/ 7 ½"



Yankauer
PB.30.00
27 cm/ 11"

Cartridge / Water Syringes



Chiropody Instruments

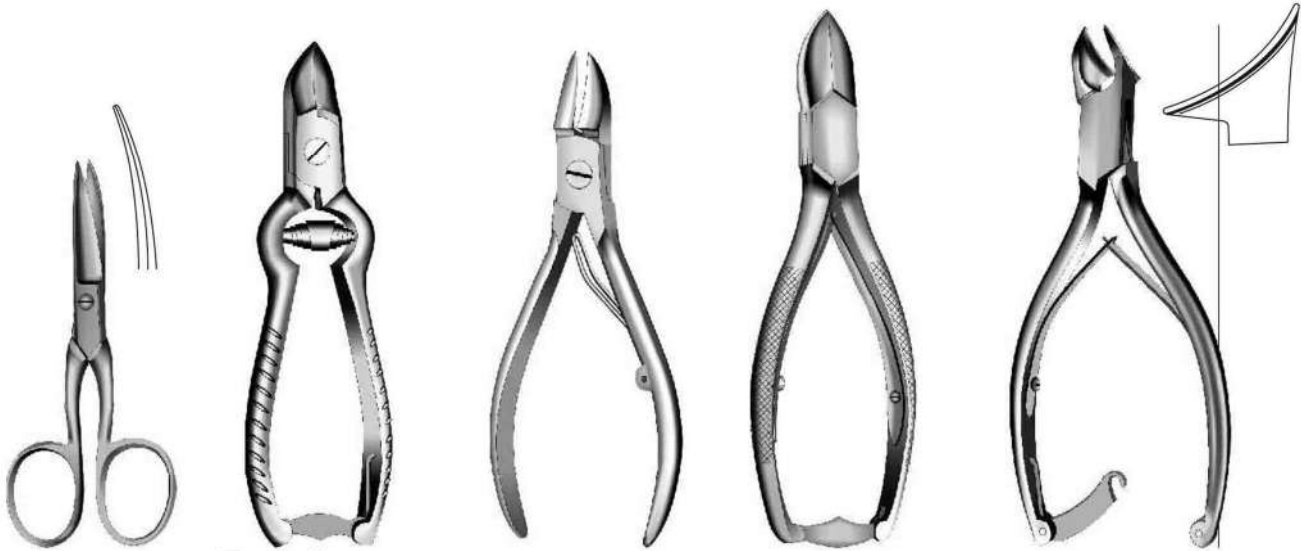

PAR.04.10
10 cm / 4"

Turnbull
PAR.07.81 = 11.5 cm / 4 1/2"
PAR.07.83 = 13 cm / 5"

PAR.08.13
13 cm / 5"

PAR.09.14 = 14 cm / 5 1/2"
PAR.09.16 = 16 cm / 6 1/4"

PAR.10.84
14 cm / 5 1/2"

Sterilization Forceps



Cheatele
PR.03.27
27 cm / 10 1/2"

PAD.19.30
30 cm / 12"

20-1919 = 19 cm / 7 1/2"
20-1922 = 22 cm / 8 1/2"
20-1925 = 25 cm / 10"

Spatulas



20-2021
21 cm / 8 1/4"
105 x 30 mm
elastic

20-2120
20 cm / 8"
100 x 23 mm
rigid

20-2219
19 cm / 7 1/2"
100 x 17 mm
elastic

Napkin Holders



**Professional
20-2301**
length adjustable



**Adams
20-2302**

Finger Guards



20-2401

20-2402

20-2403

**Langenbeck
20-2401 - 20-2403**

Sand glass



20-2500

Spring Caliper



20-2601



20-2602

Micro meters



**Boley
20-2710**

0 - 100 mm



**Iwanson
20-2603**



**Iwanson
20-2604**

Oral wedge



**Maunder
PAQ.64.10**



Ø mm	Sizes	Plane, Cone-Socket	Magnifying, Cone Socket	Ø mm	Sizes	Plane, simple thread	Magnifying, simple thread
22	4	20-2922	20-3022	22	4	20-3122	20-3222
24	5	20-2924	20-3024	24	5	20-3124	20-3224

Handles for mirrors

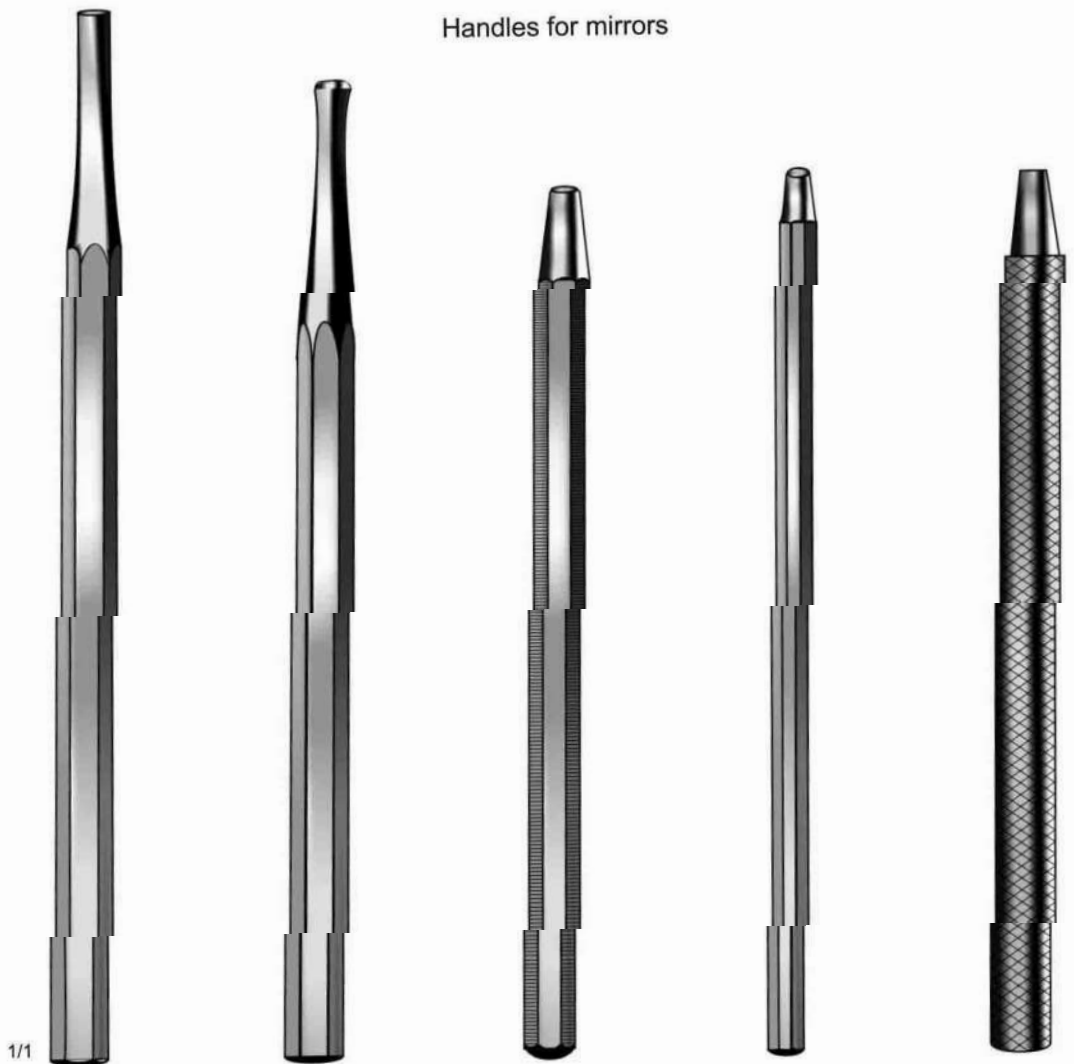

1/1	With simple thread	20-3301	Secco	20-3401	20-3501	20-3601	20-3701
	With Cone-Socket	20-3302					

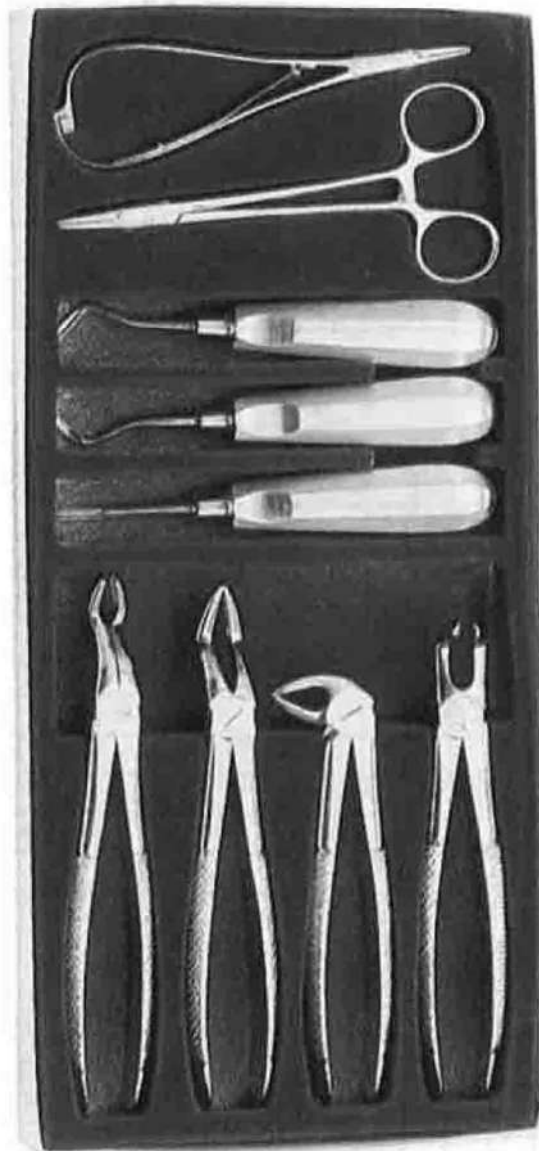

Dental Instruments Sets
Satz Instrumente
Sistema de instrumentos
Ensemble d' instruments
Insiee degli strumenti

Tel# 0092-52-4260785
Fax# 0092-52-4266804
Email. Info@benison.com.pk

Supplied in Leather wallets

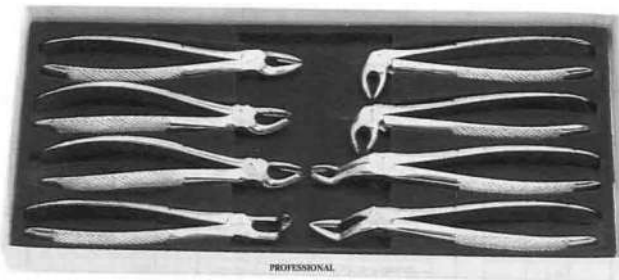

21-0108, Set of 8., Containing

- 01-0101 Dental Extracting Forceps, No.1
- 01-0113 Dental Extracting Forceps, No.13
- 01-0117 Dental Extracting Forceps, No.17
- 01-0118 Dental Extracting Forceps, No.18
- 01-0751 Dental Extracting Forceps, No.51A
- 01-1067 Dental Extracting Forceps, No.67
- 01-1379 Dental Extracting Forceps, No.39

21-0209 Set of 9, Containing

- 01-0333 Dental Extracting Forceps, No.33
- 01-0751 Dental Extracting Forceps, No.51A
- 01-1067 Dental Extracting Forceps, No.67
- 01-1379 Dental Extracting Forceps, No.79
- 05-0203 Root Elevators, 3mm, 13.5 cm/ 5¼"
- 05-2302 Root Elevators, No. 302
- 05-2303 Root Elevators, No. 303
- PJ.69.14 Mayo Hegar Needle Holder, 16 cm, T/C
- PJ.23.56 Mathieu Needle Holder, 14cm, T/C

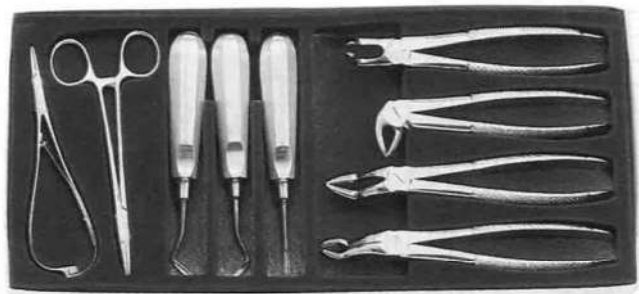

21-0309 Set of 9 , Containing

- 01-0333 Dental Extracting Forceps, No.33
- 01-0751 Dental Extracting Forceps, No.51
- 01-1067 Dental Extracting Forceps, No.67
- 01-1379 Dental Extracting Forceps, No.79
- 05-0203 Root Elevators, 3mm, 13.5 cm/ 5¼"
- 05-2302 Root Elevators, No. 302
- 05-2303 Root Elevators, No. 303
- 05-4320 Dental Extracting Forceps, No.320
- 05-4321 Dental Extracting Forceps, No.321

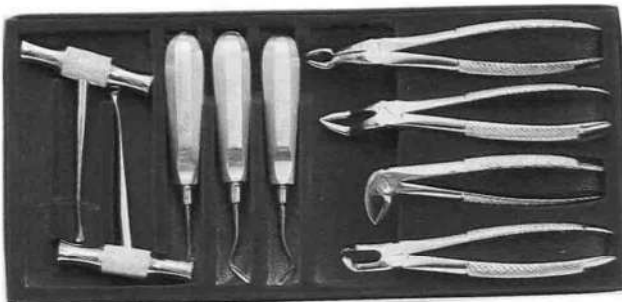

21-0408 Set of 8, Containing

- 01-0101 Dental Extracting Forceps, No.1
- 01-0104 Dental Extracting Forceps, No.4
- 01-0107 Dental Extracting Forceps, No.7
- 01-0113 Dental Extracting Forceps, No.13
- 01-0117 Dental Extracting Forceps, No.17
- 01-0118 Dental Extracting Forceps, No.18
- 01-0220 Dental Extracting Forceps, No.20
- 01-1686 Dental Extracting Forceps, No.6C



Periodontal Instruments Set

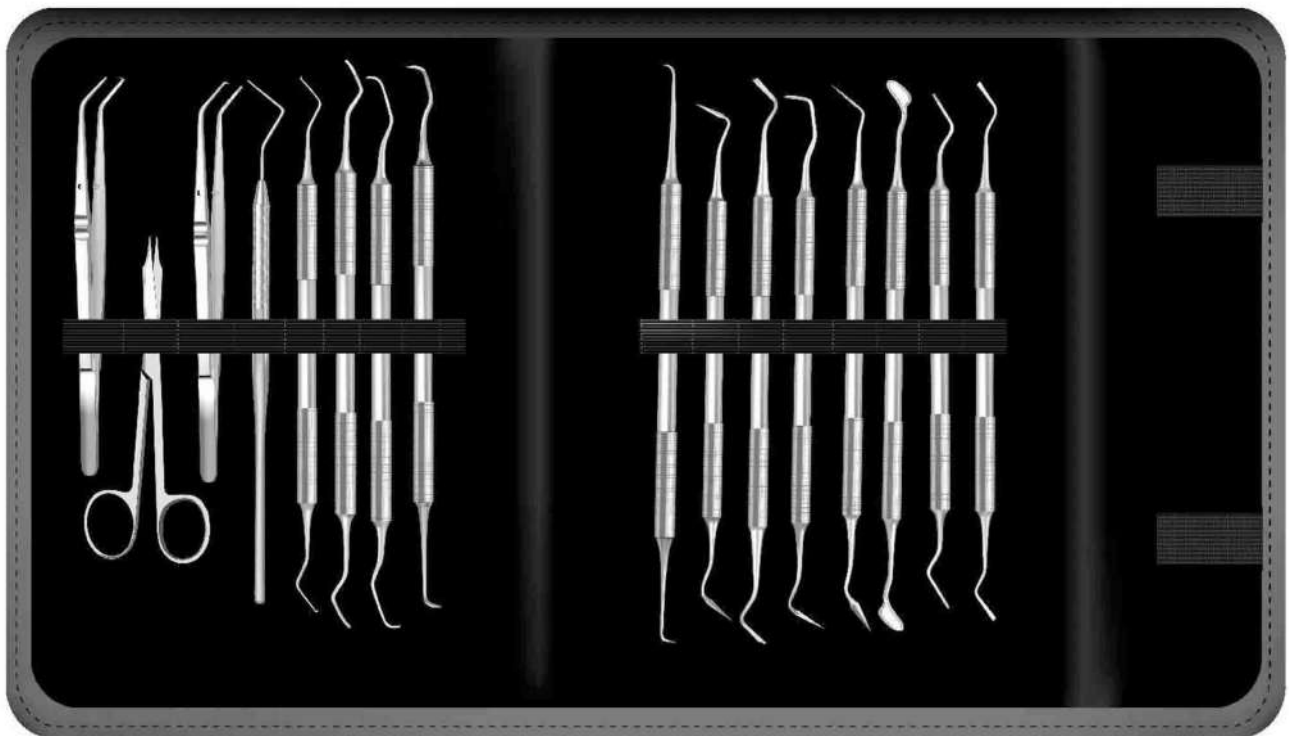

21-0508 Set of 16 Periodontia Instruments, Containing in artificial Leather case :

- 08-2101** Goldman-Fox Currettes 16cm/ 6 1/4"
- 08-2102** Goldman-Fox Currettes 16cm/ 6 1/4"
- 08-2103** Goldman-Fox Currettes 16cm/ 6 1/4"
- 08-2104** Goldman-Fox Currettes 16cm/ 6 1/4"
- 08-2105** Goldman-Fox Currettes 16cm/ 6 1/4"
- 08-2106** Goldman-Fox Currettes 16cm/ 6 1/4"
- 08-1507** Goldman-Fox Knives
- 08-1508** Goldman-Fox Knives
- 08-1509** Goldman-Fox Knives
- 08-1510** Goldman-Fox Knives
- 08-1511** Goldman-Fox Knives
- 08-1521** Goldman-Fox Knives
- PC.90.13** Goldman Fox, Gum Scissors 13 cm/ 5 1/8"
- 15-3301** Crane-Keplan Dental Tweezers 14 cm/ 5 1/2"
- 15-3302** Crane-Keplan Dental Tweezers 14 cm/ 5 1/2"

	<i>Page</i>		<i>Page</i>
A			
Abell Pliers, Contouring	89	Crane-Kaplan Dental Tweezers	104
Adams Napkin Holders	129	Crane-Kaplan Gingivectomy Knives	51
Adams Pliers, Wire, Arch and Clasp Bending	89,94	Crile-Wood Needle Holders	107
Aderer Pliers, Wire, Arch and Clasp Bending	89,93	Crile-Wood Needle Holders, TC	108
Adson Forceps, Dissecting TC	102	Cross Periodontia Instruments	53
Adson Forceps, Dressing	102	Crown Instruments	71,72
Adson Forceps, Tissue	102	Cryer Extracting Forceps, American Pattern	23
Adson Suction Tubes	126	Cryer Root Elevators	28
Adson-Brown Forceps	102	Cups, Finger	36
Ainsworth Rubber Dam Instruments	74	Curettes, Bone	115-117
Albrecht Dental Tweezers	104	Curettes, Universal	47,48
Allis Forceps, Tissue and Organ Holding	106	Cushing Forceps, Dissecting, TC	102
Allis-Baby Forceps, Tissue and Organ Holding	106	Cutting Instruments	66
Amalgam Instruments	35-37		
Andrew Tongue Depressors	118	D	
Angle Pliers, Wire, Arch and Clasp Bending	89,94	Darby-Perry Excavators	60
Apical Flohr Root Elevators	28	Darby-Perry Scalars	46
Apical Root Elevators	28	Davis-Boyle Mouth Gags	118
Articulating Forceps	104	De La Rosa, Pliers	91
Ash Gum Knives	98	Dean Gum Scissors	100
Ash Plastic Filling Instruments	39	Dean Gum Scissors, TC	101
Axial Filling Instruments	40,41	Decimal Spring Calipers	129
		Denhart Mouth Gag	114
		Derf Needle Holders, TC	108
		Diamant End and Side Nipper	89
		Dispenser, Gauze and Cotton	122
		Dividing Compasses	129
		Dressing Forceps	102,105
		Drums, Sterilization	123
		Dumont Pliers	88
B			
Babcock Forceps, Tissue and Organ Holding	106		
Baby-Crile Needle Holders	108	E	
Backhaus Towel Forceps	105	Ehrlicke Stainless Steel Impression Trays	85-86
Barnhart Universal Curettes	48	Elevators & Raspatories	111
Bates Universal Curettes	48	Elevators, Root	27-32
Beale Wax, Porcelain and Modelling Carvers	70	Ermet Wax Knife	70
Bein Root Elevators	27	Excavators	58-61
Bennet Plastic Filling Instruments	38	Explorers	62-63
Beyer Forceps, Bone Rongeur	112	Extracting Forceps for Children, American Pattern	15
Black Cutting Instruments	66	Extracting Forceps for Children, English Pattern	12-14
Blumenthal Forceps, Bone Rongeur	112	Extracting Forceps	2-24
Bohler Bone Rongeurs	112	Extracting Forceps, with Alfa handle	11
Bohn Crown Instrument	72	Extracting Forceps, American Pattern	16-24
Boley Sliding Caliper	129	Extracting Forceps, English Pattern	2-10
Bone Curettes	115-117		
Bow Compasses	129	F	
Bowls, Kidney	121	F. Barry Root Elevators	30
Bowls, Round	120	Farabeuf Retractors, Soft Tissue	109
Bowmann Lacrimal Probes	113	Farrell Cotton Applicators	113
Boxes, Instrument	121,122	Fedi Periodontia Instruments	55
Brewer Rubber Dam Instruments	74	Fehnenstock, Wax Knife	70
Bruenings Tongue Depressors	113	Files	66
Bunting Universal Curettes	48	Finger Protectors	129
Burnishers	42	Flagg Dental Tweezers	103
Byrd Suction Tubes	126	Flohr Root Elevators	28
		Forceps	102-106
		Forceps, Artery	105,106
		Forceps, Bone Cutting	112
		Forceps, Bone Rongeur	112
		Forceps, Dissecting, TC	102
		Forceps, Splinter	106
		Forceps, Sterilizing	128
		Forceps, Tissue and Organ Holding	106
		Forceps, Tissue	102,106
		Forceps, Tongue Holding	118
		Forceps, Towel	105
		Frahm Wax, Porcelain & Modelling Carver	68
		Frazier Skin Hook	109
		Frazier Suction Tubes	126
		Freer Elevator	111
		Friedman Forceps, Bone Rongeur	111
		Friedman Root Elevators	26
		Furrer pliers, Copper Ring and Bridge Removing	90
C			
Calipers	129		
Cartridge Syringes	127		
Cases, Needle Sterilizing	120		
Castroviejo Needle Holder	107		
Caulk Dental Tweezers	104		
Cement Spatula	43,44		
Cheatle Forceps, Sterilizing	128		
Chip Blowers	127		
Chiropody Instruments	128		
Chisels, Bone	115		
Chompret Root Elevators	29		
Citelli Bone Rongeurs	111		
Cleveland Forceps, Bone Cutting	112		
Cogswell Suction Tubes	126		
Coleman Root Elevators	29		
Collin Forceps, Tongue Holding	118		
Collin Mallets	116		
Collin-Hartmann Retractors, Soft Tissue	109		
Columbia Scalars & Curettes	47		
Containers for Cotton Wool	122		
Cottle Bone chisels	115		
Cotton Applicators	113		
Cotton Dispenser	122		
Coupland Root Elevators	27		
Coupland Suction Tubes	126		
Crane Pick Root Elevators	28		

	<i>Page</i>		<i>Page</i>
G			
Gauze Packers	113	Lecluse Root Elevators	31
Gillies Needle Holder	107	Locklin Gum Scissors	100,101
Gillies Needle Holders, TC	108	Locklin Gum Scissors, TC	101
Gillies Skin Hooks	109	Lodo Pliers, Copper Ring and Bridge Removing	90
Gingivectomy Knives	51	London College Tweezers, Cotton	103
Gisy-Wild Wax, Porcelain and Modelling Carver	70	Lowrence Read, Extracting Forceps	08
Goldman Fox Periodontia Instruments	53,54	Lucas Bone Curettes	117
Goldman Universal Curettes	48	Luer Forceps, Bone Rongeur	112
Gracey Periodontia Instruments	56	Luks Nerve Instruments	65
Gross-Maier Dressing & Cotton Swab Forceps	105	Luniathek Gauze Packers	113
Gum Knives	98		
Gum Scissors	100	M	
Guthrie Skin Hooks	109	Mallery Universal Curettes	48
Guy Tongue Holding Forceps	118	Mallets	116
		Mathieu Needle Holders	107
H			
Halsey Needle Holders, TC	108	Mathieu Needle Holders, TC	108
Halsted-Mosquito Artery Forceps	105	Matrix Bands	73
Handle for Mouth Mirrors	130	Matrix Retainers	73,74
Harris Extracting Forceps, American Pattern	17-18	Maunder Wedges, Oral	129
Hartmann Forceps, Artery	105	Mayo Hegar Needle Holders	107
Heidebrink Root Elevators	29	Mayo Hegar Needle Holders, TC	108
Heidemann Plastic Filling Instruments	39	Mayo Tongue Depressors	113
Heister Mouth Gags	114	McCall Periodontia Instruments	52
Hemingway Mod Bone Curettes	116	McCall Scalers	46
Henahan Extracting Forceps, American Pattern	16	McIvor Mouth Gags	118
Hirschfeld Files	66	Mckellops Pliers	95
Hollenback Amalgam Instruments	37	Mead Extracting Forceps	10
Hollenback Wax, Porcelain & Modelling Carvers	68	Mead Mallets	116
Hooks, Skin	109	Measuring Instruments	129
How Pliers	89,94	Meriam Tweezer, Cotton and Dressing	103
Hull Extracting Forceps, American Pattern	21	Mershon Instruments for Crown Work	71
Hygienist Periodontia Instruments	52	Methot Dispensers, Gauze and Cotton	122
Hylin Root Elevators	27	Metzenbaum Delicate Scissors, Dissecting	99
Hylin Wax Knife	69	Metzenbaum Delicate Scissors, TC	101
		Metzenbaum Scissors, Dissecting	99
I			
Impression Trays	76-86	Micrometers	129
Indiana University Universal Curettes	48	Micro-Ryder Needle Holder TC	108
Instruments for Crown Work	71,72	Miller Paper Clip	71
Interproximal Wax, Porcelain & Modelling Carvers	68	Miller Root Elevators	28
Ivory Amalgam Instruments	36	Miller-Colbrun Bone Curettes	117
Ivory Matrix Retainers	73,74	Mirrors, Mouth	130
Iwanson Decimal Spring Calipers	129	Mod. PHF Bone Curettes	116
		Mod. Plastic Filling Instruments	38,40
J			
Jaquette Periodontia Instruments	52	Mod. USA Amalgam Instruments	37
Jaquette Scalers	46	Molt Mouth Gag	114
Jarabak Pliers	93	Molt Raspatories, Periosteal	111
Jars, Forceps	121	Mouth Gags	114,118
Jennings Mouth Gags	114		
Johnson Pliers, Contouring	89	N	
Jones Towel Forceps	105	Nabers Pernodontia Instruments	53
		Napkin Holders	129
K			
Kells Extracting Forceps, American Pattern	22	Needle Cases	120
Kelly Gum Scissors, TC	101	Needle Holders	107,108
Kerrison Bone Rongeurs	111	Needle Holders, TC	108
Keyes Dermal Punch	113	Nerve Instruments	64,65
Kidney Trays	121	Nevius Extracting Forceps, American Pattern	21,22
Kilner Skin Hook	109	Nippers, Cuticle	128
Kirkland Gingivectomy Knives	51	Nippers, Nail	128
Klein Extracting Forceps for Children, with Spring	14	Norm Trays	124
Knives & Scalpels	98	Nuboer Suction Tubes	126
Konrich Sterilizing Drums	123		
Krallengnber Elevators	31	O	
Kroenig Tongue Depressors	113	Obwegeser Retractors, Soft Tissue	110
		Ochsenbein Periodontia Instruments	55
L			
La Grange Gum Scissors	100	Ochsner-Kocher, Hemostatic Forceps	106
Langenbeck Elevators	111	Olsen Hegar Needle Holders	107
Langenbeck Finger Protectors	129	Olsen-Hegar Needle Holders, TC	108
Langenbeck Retractors	110	Oringer Self retaining Cheek Lip Retractors	114
Langer Scalers & Curettes	47		
Le Cron Wax, Procelain & Modelling Carvers	70	P	
		Parmly Extracting Forceps, American Pattern	19
		Partsch Chisels, Bone	115
		Passow Bone Chisels	115
		Periodontia Instruments	50-56
		Perry Dental Tweezers	103
		Physick Extracting Forceps, American Pattern	16

	Page		Page
Plastic Filling Instruments	38-41	Suction Tubes	126
Pliers, Bond Bracket	91,92	Surgery Instruments	125-130
Pliers, Contouring	89	Syringes Cartridges	127
Pliers, Copper Ring and Bridge Removing	90	Syringes, Water	127
Pliers, Crown	89		
Pliers, Flat Nose	88	T	
Pliers, Loop Forming & Bending	94,95	Thomas Modelling Carvers	69
Pliers, Orthodontic	88-96	Tobold Tongue Depressors	118
Pliers, Bar Bending	88	Tofflemire Matrix Bands	73
Pliers, Band Seating	91	Tofflemire-Universal Matrix Retainers	73
Pliers, Universal	90	Tomes Extracting Forceps	20
Pliers, Wire Arch and Clasp Bending	89,91-93	Tongue Depressors	113,118
Pliers, Wire Cutting Pliers	96	Towner Jaquette Periodontia Instruments	52
Pott Root Elevators	31	Trays, Half	124
Prichard Periodontia Instruments	53	Trays, Instruments Storing	120
Probes (Explorers)	62-63	Trays, Norm	124
Probes Periodontia	50	Trays, Universal	100
Professional Napkin Holders	129	Treyemann Instruments for Crown Work	71
		Tuft Wax, Procelain and Modelling Carvers	68
Q		Turnbull Nipper, Nail	128
Quinby Gum Scissors	100	Tweed Bending & Forming Pliers	93,95
		Tweezers, Cotton & Dressing	103,104
R		U	
Ragnell (Kilner) Gum Scissors, TC	101	Universal Curettes	47,48
Ralk Forceps, Splinter	106	Universal Pliers	90
Raspatories, Periosteal	111	Universal Wire and Crown Scissors	100,101
Retractors	109-110	USA-Mod Dental Tweezers	104
Retractors, Cheek and Lip	113		
Retractors, Soft Tissue	110	V	
Reynolds Pliers	89,93	Vestibulum-Haken	114
Rochester-Pean Hemostatic Forceps	106	Volkman Bone Curettes	115
Root Elevators	26-32	Volkman Retractors	110
Roser Konig Mouth Gag	114		
Roux Retractors	109	W	
Rubber Dam Instruments	74	Wagner Gum Scissors	100
Rule Universal Curettes	48	Waldsachs-Universal Pliers	90
		Walter F. Barry Root Elevators	28,30,32
S		Ward Wax, Porcelain and Modelling Carver	68
Sachs Instruments for Crown Work	71	Ward-Kirkland Periodontia instruments	51
Sand Glass	129	Warwick James Root Elevators	32
Scalers	46-48	Wax, Porcelain and Modelling Carvers	68-70
Scalpel Handles	98	Wedges, Oral	129
Scalpel Blades	98	Weingart Pliers	94
Schimmelbusch Sterilizing Drums	123	West Root Elevators	32
Schroeder Instruments for Crown Work	71	White Burnishers	42
Schwarz Pliers, Bar Bending	88	White Excavators	59
Scissors	99-101	White Plastic Filling Instruments	39
Scissors, Cuticle	128	Wieder Tongue Depressors	118
Scissors, Dissecting	99,101	Wiland Wax, Porcelain and Modelling Carvers	68
Scissors, Gum	99,100	Williams Plastic Filling Instruments	38
Scissors, Gum, TC	101	Williger Bone Curettes	115
Scissors, Nail	128	Williger Elevators	111
Scissors, Operating Fine	99	Winter Root Elevators	30
Scissors, Operating	99	Woodson Plastic Filling Instruments	39
Scissors, TC	99,101	Woodward Extracting Forceps	17
Scissors, Wire and Crown	100,101		
Seldin Root Elevators	28	Y	
Semken Tissue Forceps	102	Yankauer Suction Tubes	126
Senn-Miller Retractors	109	Yonger Good Universal Curettes	48
Sets, Dental Instruments	132,133	Young Pliers, Wire, Arch and Clasp Bending	89
Sliding Caliper	129		
Spatulas	128	Z	
Spatulas, Cement	43,44,128	Zahle Wax Knife	69
Spirit Lamp	122		
Spring Calipers	129		
Stadler Pliers	89		
Standard Extracting Forceps, American Pattern	16-24		
Standard Forceps, Dressing	102		
Standard Scalpel Handles	98		
Standard Scissors, Operating	99		
Sterilization	119-124		
Sterilizing Drums	123		
Sternberg Retractors, Cheek and Lip	113		
Stieglitz Splinter Forceps	106		
Stockes Rubber Dam Instruments	74		